

This Instrument Prepared By
and Return to:

Leigh Ann Murvin, P. L.
Broad and Cassel
390 North Orange Avenue, Suite 1100
Orlando, Florida 32801

**DECLARATION OF CONDOMINIUM
OF
MIRABELLA, A CONDOMINIUM**

Omni-Tivoli, LLC, a Florida limited liability company (hereinafter called the "Developer"), does hereby declare as follows:

1. **Introduction and Submission.**

1.1 **The Land.** The Developer owns the fee title to that certain land located in the City of Jacksonville, Duval County, Florida, as more particularly described in **Exhibit "1"** annexed hereto and made a part hereof (the "Land").

1.2 **Submission Statement.** The Developer hereby submits the Land and all improvements erected or to be erected thereon, all easements, rights and appurtenances belonging thereto, and all other property, real, personal or mixed, now or hereafter situated on or within the Land - but excluding all public and private (e.g., cable television) utility installations therein or thereon - to the condominium form of ownership and use in the manner provided for in the Florida Condominium Act as it exists on the date hereof. Without limiting any of the foregoing, no property, real, personal or mixed, not located within or upon the Land as aforesaid shall for any purposes be deemed part of the Condominium (hereinafter defined) or be subject to the jurisdiction of the Association (hereinafter defined), the operation and effect of the Florida Condominium Act or any rules or regulations promulgated pursuant thereto, unless expressly provided.

1.3 **Name.** The name by which this condominium is to be identified is **MIRABELLA**, a Condominium (hereinafter called the "Condominium").

2. **Definitions.** The following terms when used in this Declaration and in its exhibits, and as it and they may hereafter be amended, shall have the respective meanings ascribed to them in this Section, except where the context clearly indicates a different meaning:

- 2.1 "Act" means the Florida Condominium Act (Chapter 718 of the Florida Statutes) as it exists on the date hereof and as amended from time to time.
- 2.2 "Articles" or "Articles of Incorporation" mean the Articles of Incorporation of the Association appended hereto as **Exhibit "2"** and made a part hereof, as amended from time to time.
- 2.3 "Assessment" means a share of the funds which are required for the payment of Common Expenses which from time to time is assessed against the Unit Owners. Assessments may include the Association's obligation to pay the pro-rata share of the total cost of maintaining and operating the Lake No. 8 as set forth in the Lake Meadowbrook Declaration (as defined herein) and Lake No. 1 as set forth in the Lake No. 1 Easement Agreement (as defined herein).
- 2.4 "Association" or "Condominium Association" means Mirabella I Condominium Association, Inc., a Florida corporation not-for-profit, the sole entity responsible for the operation of the Condominium, in accordance with the terms of this Declaration and the Act.
- 2.5 "Association Property" means the property, real and personal, which is owned or leased by, or is dedicated by a recorded plat to, the Association for the use and benefit of its members.
- 2.6 "Board" or "Board of Directors" means the board of directors, from time to time, of the Association which is responsible for the administration of the Association.
- 2.7 "Building" and "Buildings" means the structure(s) located or to be located on the Condominium Property in which the Units, Common Elements and Limited Common Elements are located.
- 2.8 "By-Laws" mean the By-Laws of the Association, appended hereto as **Exhibit "3"** and made a part hereof, as amended from time to time.
- 2.9 "Common Elements" means and includes the portions of the Condominium Property which are not included in the Units, including, without limitation, the following items:
- (a) Easements through Units for conduits, pipes, ducts, vents, plumbing, wiring and other facilities, equipment and/or fixtures for the furnishing of Utility Services and/or heating, cooling, ventilation or other services to Units or to the Common Elements, together with related property and installations;
 - (b) An easement of support in every portion of a Unit which contributes to the support of a Building, other Units and/or any part of the Common Elements;

- (c) The property and installations required for the furnishing of utilities and other services to more than one Unit or to the Common Elements; and
 - (d) Any other parts of the Condominium Property designated as Common Elements in this Declaration or the Act.
- 2.10 "Common Expenses" means all expenses properly incurred by the Association in performance of its duties for the Condominium, including, but not limited to: (1) expenses of maintenance, operation, protection, repair or replacement of the Common Elements and Association Property; (2) expenses declared to be Common Expenses by the provisions of this Declaration or by the Articles, By-Laws or the Act; and (3) the costs of carrying out the powers and duties of the Association. Common Expenses also include reasonable transportation services, insurance for directors and officers, road maintenance and operation expenses, in-house communications, security services, and pest control services to the Common Elements, which are reasonably related to the general benefit of the Unit Owners even if such expenses do not attach to the Common Elements or property of the Condominium, and the cost of a master antenna television system, duly franchised cable television service, broadband, telecommunications, satellite and/or internet services obtained pursuant to a bulk contract. Common Expenses shall not include any separate obligations of individual Unit Owners.
- 2.11 "Common Surplus" means the excess of all receipts of the Association collected on behalf of the Association, including, but not limited to, Assessments, rents, profits and revenues on account of the Common Elements, over the amount of Common Expenses.
- 2.12 "Condominium Parcel" means a Unit, together with the undivided share in the Common Elements which is appurtenant to said Unit and when the context permits, the term includes all other appurtenances to the Unit.
- 2.13 "Condominium Property" means the Land, Improvements and personal property described in subsection 1.2 hereof, subject to the limitations thereof and exclusions therefrom that are subjected to condominium ownership under this Declaration, and all easements and rights appurtenant thereto intended for use in connection with the Condominium.
- 2.14 "County" means the County of Duval, State of Florida.
- 2.15 "Declaration" or "Declaration of Condominium" means this instrument and all exhibits attached hereto, as the same may be amended from time to time.
- 2.16 "Developer" means Omni-Tivoli, LLC, a Florida limited liability company, its successors and such of its assigns as to which the rights of the Developer hereunder are specifically assigned by an instrument executed and recorded by the Developer. The Developer may assign all or a portion of its rights hereunder, or all or a portion of such rights in connection with specific portions of the Condominium Property. In the event of any partial assignment, the assignee shall

not be deemed the Developer, but may exercise such rights of the Developer as are specifically assigned to it. Any such assignment may be made on a non-exclusive basis. The rights of the Developer under this Declaration are independent of the Developer's rights to control the Board of Directors of the Association and, accordingly, shall not be deemed waived, transferred or assigned to the Unit Owners, the Board, or the Association upon the transfer of control of the Association.

- 2.17 "Division" means the State of Florida Division of Land Sales, Condominiums, and Mobile Homes of the Department of Business and Professional Regulation.
- 2.18 "Improvements" mean all structures and artificial changes to the natural environment (exclusive of landscaping) located or are to be constructed on the Land, including, but not limited to, the Buildings.
- 2.19 "Institutional First Mortgagee" means a bank, savings and loan association, insurance company, real estate or mortgage investment trust, pension fund, agency of the United States Government, mortgage banker, the Federal National Mortgage Association, the Federal Home Loan Mortgage Corporation or any other lender generally recognized as an institutional-type lender, or the Developer, holding a first mortgage on a Unit or Units. A "Majority of Institutional First Mortgagees" shall mean and refer to Institutional First Mortgagees of Units by which greater than one-half (1/2) of the voting interests of Units subject to mortgages held by Institutional First Mortgagees are encumbered.
- 2.20 "Lake Meadowbrook Association" means the Lake Meadowbrook Lake Owners' Association, Inc., a Florida not-for-profit corporation, which is responsible for all maintenance obligations of the surface water and stormwater management system of Lake No. 8 for which St. Johns River Water Management District issued Permit No. 4-031-0510 with respect to Lake No. 8.
- 2.21 "Lake Meadowbrook Declaration" means the Declaration of Covenants and Restrictions for Operation and Maintenance of Surface Water or Storm Water Management System dated October 30, 1995 and recorded in Official Records Book 8207, Page 785, Public Records of Duval County, Florida, as amended by that certain First Amendment to Declaration of Covenants and Restrictions for Operation and Maintenance of Surface Water or Storm Water Management System dated September 26, 2000 and recorded in Official Records Book 9760, Page 851, Public Records of Duval County, Florida.
- 2.22 "Lake No. 1" means the lake constructed on that portion of property described in Exhibit "C" of the Declaration of Covenants and Restrictions for Operation and Maintenance of Surface Water or Storm Water Management System dated October 30, 1995 and recorded in Official Records Book 8207, Page 785, Public Records of Duval County, Florida, as amended by that certain First Amendment to Declaration of Covenants and Restrictions for Operation and Maintenance of Surface Water or Storm Water Management System dated September 26, 2000

and recorded in Official Records Book 9760, Page 851, Public Records of Duval County, Florida.

- 2.23 "Lake No. 8" means the easement property described in Exhibit "A" of the Drainage Easement Agreement dated February 20, 2001 and recorded in Official Records Book 9892, Page 1905, Public Records of Duval County, Florida.
- 2.24 "Lake Number One Association" means the Lake Number One Owners' Association, Inc., a Florida not-for-profit corporation, which is responsible for maintaining Lake No. 1 in conformance with all permits applicable thereto as established by the Lake Number One Easement Agreement as defined in Section 2.25 herein.
- 2.25 "Lake Number One Easement Agreement" means the covenants, conditions, restrictions and provisions for assessments as contained in the Drainage Easement Agreement dated February 20, 2001 and recorded in Official Records Book 9892, Page 1905, Public Records of Duval County, Florida.
- 2.26 "Limited Common Elements" means those Common Elements of which the uses are reserved to a certain Unit or Units to the exclusion of other Units, as specified in this Declaration. References herein to Common Elements also shall include all Limited Common Elements unless the context would prohibit or it is otherwise expressly provided.
- 2.27 "Primary Institutional First Mortgagee" means the Institutional First Mortgagee which owns, at any time, Unit mortgages securing a greater aggregate indebtedness than is owed to any other Institutional First Mortgagee. Notwithstanding the foregoing, General Electric Capital Corporation ("GEC") is hereby designated the Primary Institutional First Mortgagee until such time as the recorded Mortgage in favor of GEC is satisfied of record in the Public Records of Duval County, Florida.
- 2.28 "Residential Limited Common Elements" shall mean all recreational facilities and amenities designated for the exclusive use of Residential Unit Owners, including the clubhouse, jacuzzi, swimming pool, sundecks, gazebo, equipment room, business center, fitness room, kid's room, club room, hospitality room, reception hall, leasing areas, break room and offices. "Common Elements" shall include Residential Limited Common Elements unless specified otherwise or context does not so permit.
- 2.29 "Residential Limited Common Expense" shall mean all expenses incurred by the Association for the operation, maintenance, repair or replacement of Residential Limited Common Elements, reserves required by the Association (to the extent not properly waived) or as established by the Association with respect to Residential Limited Common Elements.
- 2.30 "Special Assessment" means any assessment levied against Unit Owners other than the Assessment required by a budget adopted annually.

- 2.31 "System" means the Lake and any storm water conveyance, treatment and detention facilities and appurtenant structures and facilities as set forth in the Lake Meadowbrook Declaration.
- 2.32 "Unit" means a part of the Condominium Property which is subject to exclusive ownership and is used or intended to be used for residential purposes.
- 2.33 "Unit Owner" or "Owner of a Unit" or "Owner" means a record owner of legal title to a Condominium Parcel.
- 2.34 "Utility Service" means and is intended to include, but is not limited to, electric power, gas, telephone, hot and cold water, heating, air conditioning ventilation systems, garbage and sewage disposal.

3. Description of Condominium.

- 3.1 Identification of Units. The Land has constructed thereon two (2) and three (3)-story residential structures consisting of thirty (30) buildings ("Buildings"), having a total of four hundred (400) residential units ("Units"), one hundred eighty-eight (188) direct access one (1)-car garages ("Parking Garages"), five hundred and ten (510) outside parking spaces, including thirty-two (32) handicapped parking spaces ("Parking Spaces"), and sixty (60) storage spaces ("Storage Spaces"). Each Unit is identified by a separate numerical designation. The designation of each Unit is set forth on **Exhibit "4"** attached hereto and made a part hereof. **Exhibit "4"** consists of a survey of the Land, a graphic description of the Improvements located thereon, including, but not limited to, the Buildings in which the Units are located, and a plot plan thereof. Said **Exhibit "4"**, together with this Declaration, is sufficient in detail to identify the Common Elements and each Unit and their relative locations and dimensions. There shall pass with a Unit as appurtenances thereto (a) an undivided share in the Common Elements and Common Surplus; (b) the exclusive right to use such portion of the Common Elements as may be provided for in this Declaration; (c) an exclusive easement for the use of the airspace occupied by the Unit as it exists at any particular time and as the Unit may lawfully be altered or reconstructed from time to time, provided that an easement in airspace which is vacated shall be terminated automatically; (d) membership in the Association with the full voting rights appurtenant thereto; and (e) other appurtenances as may be provided by this Declaration. The construction of the Buildings which constitute the Condominium has been substantially completed as of the time of the filing of this Declaration.
- 3.2 Unit Boundaries. Each Unit shall include that part of the Building containing the Unit that lies within the following boundaries:

- (a) Upper and Lower Boundaries. The upper and lower boundaries of the Unit shall be the following boundaries extended to their planar intersections with the perimetrical boundaries:
 - (i) Upper Boundaries. The horizontal plane of the unfinished lower surface of the structural ceiling.
 - (ii) Lower Boundaries. The horizontal plane of the unfinished upper surface of the concrete floor.
- (b) Perimetrical Boundaries. The perimetrical boundaries of the Unit shall be the vertical planes of the unfinished interior surfaces of the walls bounding the Unit extended to their planar intersections with each other and with the upper and lower boundaries.
- (c) Apertures. Where there are apertures in any boundary, including but not limited to, windows and doors, the Unit's boundaries shall be extended to include the doors, windows and other fixtures located in such apertures, including all frameworks, window casings and weather stripping thereof, together with exterior surfaces made of glass or other transparent material, and all framing and casings therefore; provided, however, that the exterior surface of doors facing Common Elements shall not be included in the boundaries of the Unit and shall therefore be Common Elements.
- (d) Exceptions. In cases not specifically covered above, or in any case of a conflict or ambiguity, the survey of the Units set forth as **Exhibit "4"** hereto shall control in determining the boundaries of a Unit, except that the provisions of subsection 3.2(c) above shall control, unless specifically depicted and labeled otherwise on such survey.

3.3 Limited Common Elements. Each Unit may have, to the extent applicable and subject to the provisions of this Declaration, as Limited Common Elements appurtenant thereto:

- (a) Miscellaneous Areas, Equipment. Any area upon which is located equipment or fixtures (including air conditioning compressors) which are for the exclusive use of any particular Unit or Units and the equipment or fixtures themselves shall be Limited Common Elements of such Unit(s).
- (b) Patios, Balconies, Terraces, and Lanais appurtenant to Units. Any patio, balcony, terrace and/or lanai (and all improvements thereto) as to which direct and exclusive access shall be afforded to any particular Unit or Units to the exclusion of others shall be a Limited Common Element of such Unit(s). The Association shall be responsible for the maintenance of the structural and mechanical elements of any such Limited Common Elements, with the costs of same being a part of the Common Expenses. Each Owner shall, however, be responsible for the general cleaning, plant care and upkeep of the appearance of the area(s) and, for the repair and

replacement of any floor coverings placed or installed on any patio, balcony terrace and/or lanai. Notwithstanding anything contained herein to the contrary, in order to assure a uniform appearance within the Recreation facilities, the Association shall be responsible for the repair and maintenance of the lanais within the Recreation facilities, including, without limitation, any floor coverings thereon, with the costs thereof being Residential Limited Common Expenses. A Unit Owner using a patio, balcony, terrace and/or lanai or making or causing to be made any additions, alterations or improvements thereto agrees, and shall be deemed to have agreed, for such Owner, and his heirs, personal representatives, successors and assigns, as appropriate, to hold the Association, the Developer and all other Unit Owners harmless from and to indemnify them for any liability or damage to the Condominium and/or Association Property and expenses arising therefrom.

- (c) Parking Spaces. The Developer, in its sole discretion, reserves the right to designate and assign, with or without consideration, all automobile parking spaces situated on the Condominium Property, as shown on **Exhibit "4"** hereof, as Limited Common Elements for the exclusive use by Unit Owners of specified Units as long as it holds any Unit for sale in the ordinary course of business. Thereafter, any remaining parking spaces not delegated or assigned by Developer shall be deemed to be Common Elements under the control of the Association. After assignment to a Unit, each parking space shall pass as Limited Common Elements of the Unit to which it is assigned. No Unit Owner shall have or acquire any fee simple title to the assigned parking space at any time. To the extent available, the Developer may assign or sublease additional parking spaces to Unit Owners. Upon payment by the Unit Owners of such price as Developer deems appropriate, in its absolute discretion, the Developer shall assign or sublease an additional space or spaces to a Unit and once so assigned or subleased, said space or spaces shall become a Limited Common Element appurtenant to such Unit. All such assignments of parking spaces shall be made by a non-recordable instrument in writing ("Parking Space Designation"). The Developer will cause the Association to record each such Parking Space Designation in the records of the Association and the Unit Owner to which such use has been delegated shall have the exclusive right to the use thereof. Any Unit Owner acquiring an additional parking space shall be required to pay a monthly fee for use of the additional parking spaces. Parking Space Designations shall be executed by Developer alone, the President of the Association alone, or by any two (2) officers of the Association. There shall be no recordation in the County of the transfer of a parking space. No assignment or transfer of title in any manner whatsoever to use a parking space constituting Limited Common Elements may be made or accomplished separately from the passing of title to the Unit to which it is appurtenant, except that the same may be separately assigned by the Developer to the Condominium Association and thereafter maintained as part of the Common Elements or reassigned

by the Condominium Association, in its sole discretion, to another Unit Owner as a Limited Common Element. The Association shall assess all Unit Owners for the maintenance of any parking spaces maintained as part of Common Elements for Unit Owners, their tenants and guests, based on each Unit Owner's percentage share of Common Expenses pursuant to the budget. For good cause, or when compelled by state statute or city or county ordinance or pursuant to the Declaration, the Association shall have the right and authority to reassign parking spaces from time to time upon written notice to the affected Unit Owners. Notwithstanding the foregoing, a Unit Owner who has acquired additional parking spaces from the Developer or Association shall have the right, at any time after the Developer has assigned all additional automobile parking spaces to Unit Owners, to transfer, assign or sublease any of its parking spaces to another Unit Owner; provided, however, that each Unit shall have a minimum of one (1) parking space appurtenant thereto at all times. Upon a reassignment of a parking space by an Owner, such Owner shall promptly provide written evidence of same to the Association.

- (d) Storage Spaces. The Developer, in its sole discretion, reserves the right to assign, with or without consideration, all storage spaces situated on the Condominium Property, as shown on **Exhibit "4"** hereof, as Limited Common Elements for the exclusive use by Unit Owners of specified Units as long as it holds any Unit for sale in the ordinary course of business. Thereafter, any remaining storage spaces not so designated and assigned by Developer, shall be deemed to be Common Elements under the control of the Association. After assignment to a Unit, each storage space shall pass as Limited Common Element of the Unit. No Unit Owner shall have or acquire any fee simple title to the storage space at any time except as part of the Unit Owner's undivided share in the Common Elements. Upon payment by the Unit Owners of such price as Developer may deem appropriate, in its absolute discretion, the Developer shall assign such storage space or spaces to a Unit and once so assigned, said space or spaces shall become a Limited Common Element appurtenant to such Unit. All such assignments of storage spaces shall be made by a non-recordable instrument in writing ("Storage Space Assignment"). The Association shall maintain a book (the "Association Book") for purposes of recording the current assignee of each storage space. The Developer will cause the Association to record each such Storage Space Assignment in the Association Book and the Unit Owner to which such use is assigned shall have the exclusive right to the use thereof. All fees collected by Developer for assigning storage spaces, if any, shall be retained by Developer and shall not constitute income or revenue of the Association. Storage Space Assignments shall be executed by Developer alone, the President of the Association alone, or by any two officers of the Association. There shall be no recordation in the County of the transfer of a storage space. No assignment or transfer of title in any manner whatsoever to use a storage space constituting Limited Common Elements

may be made or accomplished separate from the passing of title to the Unit to which it is appurtenant, except that storage spaces may be separately assigned by the Developer to the Condominium Association and thereafter maintained as part of the Common Elements or reassigned by the Condominium Association, in its sole discretion, to another Unit Owner as a Limited Common Element. Notwithstanding the foregoing, a Unit Owner who has acquired a storage space from the Developer or Association shall have the right, at any time after Developer has assigned all additional storage spaces situated on the Condominium Property to Unit Owners, to transfer or assign its storage space to another Unit Owner. The assigning Unit Owner shall have the right to retain all consideration paid by the Unit Owner for the assignment of the storage space. Upon a reassignment of a storage space by an Owner, such Owner shall promptly provide written evidence of same to the Association. The maintenance of the interior of any storage space so assigned, as well as the insurance of its contents, shall be the sole responsibility of the Unit Owner to which it is assigned. Any required structural or exterior repairs required thereto shall be the responsibility of the Association and the cost thereof shall be deemed a Common Expense.

- (e) Conveyance of a Unit. All Limited Common Elements appurtenant to that Unit shall be conveyed as part of that Unit unless alternative means of conveyance are specifically provided for in this Declaration.

3.4 Easements. The following easements are hereby created (in addition to any easements created under the Act and any easements affecting the Condominium Property and recorded in the Public Records of the County):

- (a) Support. Each Unit, Building and the Improvements shall have an easement of support and of necessity and shall be subject to an easement of support and necessity in favor of all other Units and the Common Elements.
- (b) Utility and Other Services; Drainage. Non-exclusive easements are reserved under, through and over the Condominium Property as may be required from time to time for utility, cable television, communications and security systems, and other services and drainage in order to serve the Condominium and each Unit. A Unit Owner shall do nothing within or outside his or her Unit that interferes with or impairs, or may interfere with or impair, the provision of such utility, cable television, communications and security systems, or other service or drainage facilities or the use of these easements. The Association shall have an irrevocable right of access to each Unit during reasonable hours when necessary for the maintenance, repair, or replacement of any of the pipes, wires, ducts, vents, cables, conduits and other utility, cable television, communications and security systems, service and drainage facilities which are Common Elements and any other Common Elements contained

in the Unit or elsewhere in the Condominium Property, or of any portion of a Unit to be maintained by the Association pursuant to this Declaration or as necessary to prevent damage to the Common Elements or to a Unit or Units, and to remove any Improvements interfering with or impairing such facilities or easements herein reserved; provided such right of access, except in the event of an emergency, shall not unreasonably interfere with the Unit Owner's permitted use of the Unit, and except in the event of an emergency, entry shall be made on not less than one (1) day's notice, which notice shall not, however, be required if the Unit Owner is absent when the giving of notice is attempted.

- (c) Encroachments. If (a) any portion of the Common Elements encroaches upon any Unit (or Limited Common Element appurtenant thereto); (b) any Unit (or Limited Common Element appurtenant thereto) encroaches upon any other Unit or upon any portion of the Common Elements; or (c) any encroachment shall hereafter occur as a result of (i) construction of the Improvements; (ii) settling or shifting of the Improvements; (iii) any alteration or repair to the Common Elements made by or with the consent of the Association or the Developer, as appropriate, or (iv) any repair or restoration of the Improvements (or any portion thereof) or any Unit after damage by fire or other casualty or any taking by condemnation or eminent domain proceedings of all or any portion of any Unit or the Common Elements, then, in any such event, a valid easement shall exist for such encroachment and for the maintenance of same so long as the Improvements shall stand.
- (d) Ingress and Egress. A non-exclusive easement for ingress and egress in favor of each Unit Owner and resident, and his or her guests, lessees and invitees, and mortgagees, shall exist for pedestrian traffic on, over, through and across, sidewalks, accessways, streets, paths, walks, hallways, and other portions of the Common Elements (not including Limited Common Elements) and Association Property as from time to time may be intended and designated for such purpose and use and as may be necessary to provide reasonable access to the public ways; and for vehicular traffic on, over, through and across, and parking on, such portions of the Common Elements as from time to time may be paved and intended for such purpose and use and as may be necessary to provide reasonable access to the public ways. None of the easements specified in this subparagraph (d) shall be encumbered by any leasehold or lien other than those on the Condominium Parcels. Any such lien encumbering such easements (other than those on Condominium Parcels) automatically shall be subordinate to the rights of Unit Owners and the Association with respect to such easements.
- (e) Construction; Maintenance. The Developer (including its affiliates, and its or their designees, contractors, successors and assigns) shall have the right, in its (and their) sole discretion from time to time, to enter the

Condominium Property and take all other action necessary or convenient for the purpose of completing the construction thereof, or any part thereof, or any addition or renovation thereto, or any Improvements or Units located or to be located thereon, and to repair, replace and maintain, without any obligation, the Condominium Property or any part thereof when the Association fails to do so.

- (f) Exterior Building Maintenance. An easement is hereby reserved on, through and across each Unit and all Limited Common Elements appurtenant thereto in order to afford access to the Association (and its contractors and employees) to perform roof repairs and/or replacements, repairs, maintenance, and/or alterations of rooftop mechanical equipment, to perform window washing and/or other exterior maintenance and/or painting of the Building.
- (g) Sales and Leasing Activity. For as long as the Developer offers units for sale in the ordinary course of business, the Developer, its designees, successors and assigns, shall have the right to use any such Units and parts of the Common Elements or Association Property as model Units and sales and construction offices, to show model Units and the Common Elements to prospective purchasers and tenants of Units, to erect on the Condominium Property signs and other promotional material to advertise Units for sale or lease, to be exempt from any restrictions on the type of vehicle allowed to park on Condominium Property if the vehicle is engaged in any activity relating to construction, maintenance, or marketing of Units, and to take any and all actions which, in the Developer's opinion, may be helpful for selling or leasing Units or for promoting the Condominium and its operations generally.
- (h) Additional Easements. The Developer, for so long as it holds Units for sale in the ordinary course of business, and the Association, on their behalf and on behalf of all Unit Owners (each of whom hereby appoints the Developer and the Association as its attorney-in-fact for this purpose), each shall have the right to grant such additional general ("blanket") and specific electric, gas or other utility, cable television, security systems, communications or service easements (and appropriate bills of sale for equipment, conduits, pipes, lines and similar installations pertaining thereto), or modify or relocate any such existing easements or drainage facilities, in any portion of the Condominium Property, and to grant access easements or relocate any existing access easements in any portion of the Condominium Property, as the Developer or the Association shall deem necessary or desirable for the proper operation and maintenance of the Improvements, or any portion thereof, or for the general health or welfare of the Unit Owners, or for the purpose of carrying out any provisions of this Declaration, provided that such easements or the relocation of existing easements will not prevent or unreasonably interfere with the reasonable use of the Units for dwelling purposes. In addition, the Board of Directors

has the authority, without the joinder of any Unit Owner, to grant, modify, or move any easement if the easement constitutes part of or crosses the Common Elements or Association Property.

- (i) **Easement For Services.** The Association and its agents, contractors, designees, employees, successors and assigns shall have (i) a non-exclusive easement for access and use of all the Common Elements, including, but not limited to, those customarily used for pedestrian and vehicular traffic and also including driveways, parking ramps, walkways, halls and corridors, balconies, terraces, janitorial closets, mechanical/electrical rooms, trash rooms, and storage rooms for the purpose of cleaning, repairing, maintaining and improving the Building; and (ii) an irrevocable right of access to each Unit during reasonable hours, when necessary for the maintenance, repair or replacement of any Common Elements or of any portion of a Unit to be maintained by the Association pursuant to the Declaration or as necessary to prevent damage to the Common Elements or to a Unit or Units. In addition, the Association (and its agents, contractors, designees, successors and assigns) shall have an irrevocable right of access to each Unit for the purpose of obtaining hurricane shutters stored therein and for the purpose of installing such hurricane shutters in accordance with the provisions of Section 7.4 hereof, if applicable.

4. **Restraint Upon Separation and Partition of Common Elements.** The undivided share in the Common Elements and Common Surplus which is appurtenant to a Unit, and the exclusive right to use all appropriate appurtenant Limited Common Elements, shall not be separated therefrom and shall pass with the title to the Unit, whether or not separately described. The appurtenant share in the Common Elements and Common Surplus, and the exclusive right to use all Limited Common Elements appurtenant to a Unit, except as elsewhere herein provided to the contrary, cannot be conveyed or encumbered except together with the Unit. The respective shares in the Common Elements appurtenant to Units shall remain undivided, and no action for partition of the Common Elements, the Condominium Property, or any part thereof, shall be permitted, except as provided herein with respect to termination of the Condominium.

5. **Ownership of Common Elements and Common Surplus and Share of Common Expenses; Voting Rights.**

5.1 **Fractional Ownership and Shares.** The undivided fractional ownership interest in the Common Elements and Common Surplus, and the fractional share of the Common Expenses appurtenant to each Unit are set forth in **Exhibit "5"** attached hereto and made a part hereof, which shall be based upon the total square footage of each Unit in uniform relationship to the total square footage of all other Units in the Condominium.

5.2 **Voting.** Each Unit Owner shall be a member of the Association and shall be entitled to one (1) vote in the Association as to matters on which a vote by

Owners is required as provided for in the Condominium documents and the Act. If a Unit Owner owns more than one Unit, Unit Owner shall be entitled to one vote for each Unit owned.

5.3 Voting by an Entity or Multiple Owners. If a Unit is owned by an entity or more than one individual, the properly designated officers, principals, or partners of the entity or the multiple owners shall designate a voting representative by providing written notice of the name of the individual designated to vote to the Secretary of the Association.

6. Amendments. Except as elsewhere provided herein, amendments may be effected as follows:

6.1 By the Association. Notice of the subject matter of a proposed amendment shall be included in the notice of any meeting at which a proposed amendment is to be considered. A resolution for the adoption of a proposed amendment may be proposed either by a majority of the Board of Directors of the Association or by not less than one-third (1/3) of the Unit Owners of the Association. Directors and members not present in person or by proxy at the meeting considering the amendment may express their approval in writing, provided that such approval is delivered to the Secretary at or prior to the meeting. Except as elsewhere provided, approvals must be by an affirmative vote of (a) Unit Owners of not less than 66-2/3% of the Units in the Condominium and by not less than 66-2/3% of the Board of Directors of the Association; or (b) Unit Owners of not less than 75% of the Units in the Condominium.

6.2 Amendments Prior to Turnover. During the period of Developer control, the Declaration, Articles of Incorporation or the By-Laws of the Association may be amended to correct an omission or error, or to effect any other amendment by obtaining approval of a majority of the voting interests of the Board of Directors of the Association except that this procedure for amendment may not be used if such an amendment would materially and adversely affect substantial property rights of Unit Owners, unless all of the affected Unit Owners consent in writing.

6.3 Execution and Recording. An amendment, other than amendments made by the Developer alone pursuant to the Act or this Declaration, shall be evidenced by a certificate of the Association, executed either by the President of the Association or a majority of the members of the Board of Directors of the Association, which shall include recording data identifying the Declaration and shall be executed with the same formalities required for the execution of a deed. Amendments by the Developer must be evidenced by a similar certificate executed by the Developer alone. An amendment of the Declaration is effective when the applicable certificate is properly recorded in the public records of the County. No provision of this Declaration shall be revised or amended by reference to its title or number only. Proposals to amend existing provisions of this Declaration shall contain the full text of the provision to be amended; new words shall be inserted in the text and underlined; and words to be deleted shall be lined through with hyphens.

However, if the proposed change is so extensive that this procedure would hinder, rather than assist, the understanding of the proposed amendment, it is not necessary to use underlining and hyphens as indicators of words added or deleted, but, instead, a notation must be inserted immediately preceding the proposed amendment in substantially the following language: "Substantial rewording of Declaration. See provision ... for present text." Non-material errors or omissions in the amendment process shall not invalidate an otherwise properly promulgated amendment.

- 6.4 Proviso. Unless otherwise provided specifically to the contrary in this Declaration, no amendment shall change the configuration or size of any Unit in any material fashion, materially alter or modify the appurtenances to any Unit, or change the proportion or percentage by which the Owner of a Unit shares the Common Expenses and owns the Common Elements and Common Surplus, unless the record Owner(s) of the Unit(s) so affected, and all record owners of liens thereon, shall join in the execution of the amendment and the amendment is otherwise approved by not less than 66-2/3% of the voting interests of Unit Owners in the Condominium. No amendment may be adopted which would terminate, limit, eliminate, modify, prejudice, abridge or otherwise adversely affect any rights, benefits, privileges or priorities granted or reserved to the Developer or mortgagees of Units without the prior written consent of said Developer and mortgagees in each instance; nor shall an amendment make any change in the Sections hereof entitled "Insurance", "Reconstruction or Repair after Casualty", or "Condemnation" unless 66-2/3% of the Institutional First Mortgagees shall join in the amendment. Whenever the consent or joinder of a lien or mortgage holder is required, such consent or joinder shall not be unreasonably withheld or delayed. The provisions of subsections 3.4(h), 3.4(i), 6.4, 8.2(b), 8.4, 15.16, 21 and 22.13 of this Declaration may not be amended in any manner without the prior written consent of Developer, whose consent may be withheld in Developer's sole discretion.

7. Maintenance and Repairs.

- 7.1 Units. All maintenance, repairs and replacements of, in or to any Unit, whether structural or nonstructural, ordinary or extraordinary, foreseen or unforeseen, including, without limitation, maintenance, repair and replacement of hurricane screens and shutters, windows, window coverings, interior nonstructural walls, the entrance door and all other doors within or affording access to a Unit, and the electrical (including wiring), plumbing (including fixtures and connections), heating and air-conditioning equipment, fixtures and outlets, appliances, carpets and other floor coverings, all interior surfaces and the entire interior of the Unit lying within the boundaries of the Unit or other property belonging to the Unit Owner, shall be performed by the Owner of such Unit at the Unit Owner's sole cost and expense, except as otherwise expressly provided to the contrary herein. Such maintenance and repair obligation shall include, but not be limited to, the immediate repair of any leaks affecting the Unit and any further action which is necessary to stop the growth of mold and/or mildew which might affect the Unit.

- 7.2 Common Elements and Association Property. Except to the extent (i) expressly provided to the contrary herein, or (ii) proceeds of insurance are made available therefor, all maintenance, repairs and replacements in or to the Common Elements shall be performed by the Association and the cost and expense thereof shall be charged to all Unit Owners as a Common Expense, except to the extent arising from or necessitated by the negligence, misuse or neglect by specific Unit Owners, in which case such cost shall be paid solely by such Unit Owners. Such maintenance and repair obligation shall include, but not be limited to, the immediate repair of any leaks affecting the Common Elements and any further action which is necessary to stop the growth of mold and/or mildew which might affect the Common Elements.
- 7.3 Specific Unit Owner Responsibility. The obligation to maintain and repair any equipment and fixtures or other items of personal property which are contained within a particular Unit or Units (and Limited Common Elements appurtenant thereto) shall be the responsibility of the applicable Unit Owners, individually, and not the Association, without regard to whether such items are included within the boundaries of the Unit. To the extent any Limited Common Element affects more than one unit, responsibility therefore shall be shared equally by the Owner's of the affected Units.
- 7.4 Hurricane Shutters. The Association shall establish specifications pertaining to hurricane shutters, from time-to-time, to comply with applicable building codes. The Association shall also establish criteria regarding permitted color, styles and material of shutters. Any changes to the hurricane shutters shall be approved, in writing, by the Association before any installation thereof. If hurricane shutters which do not conform with the specifications of the Association are installed, the offending Unit Owner shall remove and replace those hurricane shutters with conforming hurricane shutters at the Unit Owner's sole expense. If hurricane shutters are installed, such shutters shall become part of a Unit and shall not constitute a Common Element, Limited Common Element or Association Property. No hurricane shutters shall be installed unless and until a storm watch or storm warning is announced by the National Weather Center or other recognized weather forecaster. The Association shall notify Unit Owners by posting a notice on the Condominium Property when it is permissible to install hurricane shutters. The Association shall have the right but no obligation to enter into an agreement for services to install hurricane shutters on the Units and all such expenses shall be deemed part of the Common Expenses. Any Unit Owner who plans to be absent during all or any portion of the hurricane season must prepare his or her Unit for severe weather by removing all furniture, potted plants, or other movable objects, if any, from exterior surfaces of the Unit and Limited Common Elements appurtenant thereto. Any Unit Owners absent during all or any portion of the hurricane season shall also make his or her Unit accessible to the Association for the purpose of the Association obtaining the hurricane shutters from storage and for the purpose of the Association installing the hurricane shutters on the Unit, if the Association so elects. The Unit Owner shall also prepare his or her Unit prior to departure by designating a responsible firm or

individual to care for his or her Unit should a hurricane or other major weather event threaten the Unit or should the Unit suffer hurricane damage. Any such firm or individual designated to care for a Unit shall be subject to the approval of the Association. The Association may require that the contact information for such firm or individual be provided to the Association prior to the Unit Owner's departure.

8. **Additions, Alterations or Improvements.**

8.1 **By the Association.** Whenever in the judgment of the Board of Directors, the Common Elements or the Association Property, or any part of either, shall require capital additions, alterations or improvements (as distinguished from repairs and replacements) costing in excess of 10% of the then annual budget of the Association, the Association may proceed with such additions, alterations or improvements only if the making of such additions, alterations or improvements shall have been approved by a majority of the Units represented at a meeting at which a quorum is attained. Any such additions, alterations or improvements to such Common Elements or the Association Property, or any part of either, costing in the aggregate no more than 10% of the then annual budget of the Association may be made by the Association without approval of the Unit Owners. The cost and expense of any such additions, alterations or improvements to such Common Elements shall constitute a part of the Common Expenses and shall be assessed to the Unit Owners as Common Expenses or by Special Assessment.

8.2 **By the Unit Owner.**

(a) **Consents and Permits.** No Unit Owner shall make any addition, alteration or improvement in or to the Common Elements, the Association Property, or any Limited Common Element, without the prior written consent of the Board of Directors. The Board of Directors shall have the obligation to answer, in writing, any written request by such a Unit Owner for approval of such an addition, alteration or improvement within sixty (60) days after such request and all additional information requested is received, and the failure to do so within the stipulated time shall constitute the Board of Director's consent. The Board of Directors may condition the approval in any manner, including without limitation, retaining approval rights of the contractor to perform the work. No Unit Owner shall make any addition, alteration or improvement in or to the interior of the Unit without obtaining all appropriate governmental permits which are necessary for such work and provided that such alteration, addition or improvement will not adversely affect the structural integrity of the Buildings or cause any damage to or adversely affect the Common Elements, Limited Common Elements or other Units and/or the Condominium Property. The proposed additions, alterations and improvements by the Unit Owners shall be made in compliance with all laws, rules, ordinances and regulations of all governmental authorities having jurisdiction, and with any conditions imposed by the Association with respect to design, structural integrity,

aesthetic appeal, construction details, lien protection or otherwise. A Unit Owner making or causing to be made any such additions, alterations or improvements agrees, and shall be deemed to have agreed, for such Owner, and his heirs, personal representatives, successors and assigns, as appropriate, to hold the Association, and all other Unit Owners harmless from and to indemnify them for any liability or damage to the Condominium Property and expenses arising therefrom, and shall be solely responsible for the maintenance, repair and insurance thereof from and after the date of installation or construction thereof as may be required by the Association. The Association's rights of review and approval of plans and other submissions under this Declaration are intended solely for the benefit of the Association. Neither the Developer, the Association nor any of its officers, directors, employees, agents, contractors, consultants or attorneys shall be liable to any Owner or any other person by reason of mistake in judgment, failure to point out or correct deficiencies in any plans or other submissions, negligence, or any other misfeasance, malfeasance, or nonfeasance arising out of or in connection with the approval or disapproval of any plans or submissions. Anyone submitting plans hereunder, by the submission of same, and any Owner, by acquiring title to same, agrees not to seek damages from the Developer and/or the Association arising out of the Association's review of any plans hereunder. Without limiting the generality of the foregoing, the Association shall not be responsible for reviewing, nor shall its review of any plans be deemed approval of, any plans from the standpoint of structural safety, soundness, workmanship, materials, usefulness, conformity with building or other codes or industry standards, or compliance with governmental requirements. Further, each such Owner (including the successors and assigns) having plans reviewed hereunder agrees to indemnify and hold the Developer and the Association harmless from and against any and all costs, claims (whether rightfully or wrongfully asserted), damages, expenses or liabilities whatsoever (including, without limitation, reasonable attorneys' fees and court costs at all trial and appellate levels) arising out of any review of plans by the Association hereunder.

- (b) Weight and Sound Restrictions. Unless installed by the Developer or otherwise first approved by the Board of Directors, hard and/or heavy surface floor coverings, such as tile, marble, wood and the like must be submitted to and approved, in writing, by the Board of Directors, which approval may be conditioned upon the use of appropriate soundproofing materials under such floor coverings, and must meet applicable structural requirements. Also, the installation of any improvement or heavy object must be submitted to and approved by the Board of Directors, and be compatible with the overall structural design of the Buildings. The Board of Directors may require a structural engineer to review certain of the proposed improvements, with such review to be at the Owner's sole expense. The Board will have the right to specify the exact material to be

installed on balconies and the Board reserves the right to restrict any or all floor coverings on balconies of Units. These use guidelines are consistent with good design practices for waterproofing and structural design. Owners will be held strictly liable for violation of these restrictions and for all damages resulting therefrom and the Association has the right to require immediate removal of violations. APPLICABLE WARRANTIES OF THE DEVELOPER, IF ANY, SHALL BE VOIDED BY VIOLATIONS OF THESE RESTRICTIONS AND REQUIREMENTS. FURTHER, EACH OWNER, BY ACCEPTANCE OF A DEED OR OTHER CONVEYANCE OF THEIR UNIT, HEREBY ACKNOWLEDGES AND AGREES THAT SOUND TRANSMISSION IS VERY DIFFICULT TO CONTROL, AND THAT NOISES FROM ADJOINING OR NEARBY UNITS AND/OR MECHANICAL EQUIPMENT CAN OFTEN BE HEARD IN ANOTHER UNIT. THE DEVELOPER DOES NOT MAKE ANY REPRESENTATION OR WARRANTY AS TO THE LEVEL OF SOUND TRANSMISSION BETWEEN AND AMONG UNITS AND THE OTHER PORTIONS OF THE CONDOMINIUM PROPERTY, AND EACH UNIT OWNER HEREBY WAIVES AND EXPRESSLY RELEASES ANY SUCH WARRANTY AND CLAIM FOR LOSS OR DAMAGES RESULTING FROM SOUND TRANSMISSION.

- (c) Construction by Unit Owner. Any Unit Owner making additions, alterations or improvements as provided in this Section 8.2 shall commence any such additions, alterations or improvements within three (3) months after approval by the Board of Directors and shall diligently proceed to complete such work no later than three (3) months after commencement, unless such time period is extended by the Board of Directors. In the event that the Unit Owner proceeds with any alterations, additions or improvements without the approval of the Board of Directors, then upon written notice from the Association, the Unit Owner shall remove any non-conforming improvements promptly upon receipt of such notice, at the sole cost and expense of the Unit Owner. In the event that the Unit Owner fails to remove such non-conforming alterations in accordance with the notice received from the Association, the Association shall have the right to enter the Unit and remove such non-conforming alterations and all costs and expenses so incurred by the Association shall be promptly paid by the Unit Owner who has undertaken such non-conforming alterations, or if such expenses have been paid by the Association, the Unit Owner shall reimburse the Association within ten (10) days after receipt of an invoice for such work. Any unpaid expenses due the Association shall be added to any Assessments due from the non-conforming Unit Owner.

- 8.3 By the Developer. The foregoing restrictions of this Section 8 shall not apply to Developer-owned Units. The Developer shall have the additional right, without the consent or approval of the Board of Directors or other Unit Owners, (i) to

make alterations, additions or improvements, structural and non-structural, interior and exterior, ordinary and extraordinary, in, to and upon any Unit owned by it and Limited Common Elements appurtenant thereto (including, without limitation, the removal of walls, floors, ceilings and other structural portions of the Improvements); (ii) expand, alter or add to all or any part of the recreational facilities; (iii) change the layout or number of rooms in any Developer-owned Units; (iv) add to or modify recreational facilities; and (v) change the size and/or number of Developer-owned Units by combining separate Developer-owned Units into one (1) or more Units, or otherwise (the foregoing combining may be either horizontal or vertical combining of units); provided, however, there shall be no change to the configuration or size of any Unit in any material fashion, material alteration or modification of the appurtenances to any Unit or change to the percentage interest in the Common Elements and share of Common Surplus and Common Expenses of any Unit unless the record owner of the affected Unit(s) and all record owners of mortgages or other liens on the affected Unit(s) shall join in the execution of the amendment and unless a majority of the record owners of all other Units approve the amendment. If the Developer shall make any changes in Units, as provided in this subsection, such changes shall be reflected by an amendment to this Declaration with a survey attached reflecting such authorized alteration of Units, and said amendment need only be executed and acknowledged by the Developer and any holders of institutional mortgages encumbering the said altered Units unless otherwise required by the preceding sentence or by Section 718.110(4), Florida Statutes. The survey shall be certified in the manner required by the Act.

9. **Operation of the Condominium by the Association; Powers and Duties.**

9.1 **Powers and Duties.** The Association shall be the entity responsible for the operation of the Condominium and the Association Property. The powers and duties of the Association shall include those set forth in the Articles of Incorporation and By-Laws of the Association (respectively, **Exhibits "2" and "3"** annexed hereto and made a part hereof), as amended from time to time. In addition, the Association shall have (i) all the common law and statutory powers of a corporation not for profit and for profit under the laws of Florida that are not in conflict with the provisions of the Articles, the Declaration, the By-Laws or the Act; (ii) the powers and duties set forth in the Act, and (iii) all powers and duties granted to or imposed upon it by this Declaration, including without limitation:

- (a) The irrevocable right to have access to each Unit from time to time during reasonable hours when necessary for the maintenance, repair or replacement of any Common Elements or of any portion of a Unit to be maintained by the Association pursuant to this Declaration or at any time as necessary to prevent damage to the Common Elements or to a Unit or Units.
- (b) The power to acquire title to property or to otherwise hold, convey, lease and mortgage Association Property for the use and benefit of its members

upon a vote of 75% of all the voting interests of the Units. The Association shall have the right to grant, modify or move easements which are a part of or cross Association Property as long as the easement created in subsection 3.4(h) is not modified.

- (c) The power to make and collect Assessments and other charges against Unit Owners and to lease, maintain, repair and replace the Common Elements and Association Property.
- (d) The duty to maintain accounting records according to good accounting practices, which shall be open for inspection by Unit Owners or their authorized representatives at reasonable times upon prior request.
- (e) The power to contract for the management and maintenance of the Condominium Property and to authorize a management agent (who may be an affiliate of the Developer) to assist the Association in carrying out its powers and duties by performing such functions as the submission of proposals, collection of Assessments, preparation of records, and the enforcement of rules and maintenance, repair and replacement of Common Elements with such funds as shall be made available by the Association for such purposes. The Association and its officers shall, however, retain at all times the powers and duties granted in the Articles, the By-Laws, and this Declaration and the Act, including, but not limited to, the making of Assessments, promulgation of rules and execution of contracts on behalf of the Association.
- (f) The power to borrow money, execute promissory notes and other evidences of indebtedness and to give as security therefor mortgages and security interests in property owned by the Association, if any, provided that such actions are approved by a majority of the entire membership of the Board of Directors and of the Units represented at a meeting at which a quorum has been attained, or by such greater percentage of the Board or Unit Owners as may be specified in the By-Laws with respect to certain borrowing, provided further that no such action shall be permitted while the Developer owns any Unit without the prior written consent of the Developer.
- (g) The power to adopt and amend Rules and Regulations concerning the details of the operation and use of the Units and the Condominium Property.
- (h) The power to execute all documents or consents, on behalf of all Unit Owners (and their mortgagees), required by all governmental and/or quasi-governmental agencies in connection with land use and development matters (including, without limitation, plats, waivers of plat, unities of title, covenants in lieu thereof, etc.), and in that regard, each Owner, by acceptance of the deed to such Owner's Unit, and each mortgagee of a

Unit Owner by acceptance of a lien on said Unit, appoints and designates the President of the Association, as such Owner's agent and attorney-in-fact to execute any and all such documents or consents.

- 9.2 Limitation Upon Liability of Association. Notwithstanding the duty of the Association to maintain and repair parts of the Condominium Property, the Association is not responsible for and is not the insurer or guarantor of the health, safety or welfare of Unit Owners, their families, guests, agents or contractors. Further, the Association shall not be liable to Unit Owners for injury or damage, other than for the cost of maintenance and repair, caused by any latent condition of the Condominium Property to be maintained and repaired by the Association, or caused by the elements, other Unit Owners or third parties. Further, the Association shall not be liable for any such injury or damage caused by defects in design or workmanship or any other reason connected with any additions, alterations or improvements done by or on behalf of any Unit Owners. The Association shall not be liable to any Unit Owner or lessee or to any other person or entity for any property damage, personal injury, death or other liability on the grounds that the Association did not obtain or maintain insurance (or carried insurance with any particular deductible amount) for any particular matter where (i) such insurance is not required hereby or (ii) the Association could not obtain such insurance at reasonable costs or upon reasonable terms.
- 9.3 Restraint Upon Assignment of Shares in Assets. The share of a Unit Owner in the funds and assets of the Association cannot be assigned, hypothecated or transferred in any manner except as an appurtenance to the Unit.
- 9.4 Approval or Disapproval of Matters. Whenever the decision of a Unit Owner is required upon any matter, whether or not the subject of an Association meeting, that decision shall be expressed by the same person who would cast the vote for that Unit if at an Association meeting, unless the joinder of all record Owners of the Unit is specifically required by this Declaration or by law.
- 9.5 Acts of the Association. Unless the approval or action of Unit Owners and/or a certain specific percentage of the Board of Directors of the Association is specifically required in this Declaration, the Articles of Incorporation or By-Laws of the Association, Rules and Regulations or applicable law, all approvals or actions required or permitted to be given or taken by the Association shall be given or taken by the Board of Directors, without the consent of Unit Owners, and the Board may so approve and act through the proper officers of the Association without a specific resolution. When an approval or action of the Association is permitted to be given or taken hereunder or thereunder, such action or approval may be conditioned in any manner the Association deems appropriate or the Association may refuse to take or give such action or approval without the necessity of establishing the reasonableness of such conditions or refusal.

- 9.6 Effect on Developer. If the Developer holds any Unit for sale in the ordinary course of business, none of the following actions may be taken without the prior written approval of the Developer:
- (a) Assessment of the Developer as a Unit Owner for capital improvements until the date of expiration of the Guarantee Period (hereinafter defined); and
 - (b) Any action by the Association that would be detrimental to the sales of Units by the Developer; provided, however, that an increase in Assessments for Common Expenses without discrimination against the Developer shall not be deemed to be detrimental to the sales of Units.
10. Determination of Common Expenses and Fixing of Assessments Therefor. The Board of Directors shall from time to time, and at least annually, prepare a budget for the Condominium, determine the amount of Assessments payable by the Unit Owners to meet the Common Expenses and Residential Limited Common Expenses of the Condominium and allocate and assess such expenses among the Unit Owners in accordance with the provisions of this Declaration and the By-Laws. The Board of Directors shall advise all Unit Owners promptly in writing of the amount of the Assessments payable by each of them as determined by the Board of Directors as aforesaid and shall furnish copies of the budget, on which such Assessments are based, to all Unit Owners and (if requested in writing) to their respective mortgagees. The Common Expenses shall include the expenses of a reserve for (if required by law) the operation, maintenance, repair and replacement of the Common Elements and Residential Limited Common Elements, the cost of a master antenna television system or duly franchised cable television service obtained pursuant to a bulk contract, costs of carrying out the powers and duties of the Association and any other expenses designated as Common Expenses by the Act, this Declaration, the Articles or By-Laws of the Association, Rules and Regulations or by the Association. Incidental income to the Association, if any, may be used to pay regular or extraordinary Association expenses and liabilities, to fund reserve accounts, or otherwise as the Board shall determine from time to time, and need not be restricted or accumulated. Any Budget adopted shall be subject to change to cover actual expenses at any time. Any such change shall be adopted consistent with the provisions of the By-Laws.

11. Collection of Assessments.

- 11.1 Liability for Assessments. A Unit Owner, regardless of how title has been acquired, including by purchase at a foreclosure sale or by deed in lieu of foreclosure, shall be liable for all Assessments coming due while that person is the Unit Owner. In addition, a Unit Owner shall be jointly and severally liable with the previous owner for all unpaid Assessments that came due up to the time of transfer of title. This liability is without prejudice to any right the Owner may have to recover from the previous owner the amounts paid by the Owner. The liability for Assessments may not be avoided by waiver of the use or enjoyment of any Common Elements or by the abandonment of the Unit for which the Assessments are made or otherwise.
- 11.2 Liability for Special Assessments. In the event a Unit Owner fails to pay Assessments levied against the Unit Owner, the Association may levy a Special Assessment against the Unit Owner for the outstanding amount due. Any Special Assessment, including the aforesaid, levied against a Unit Owner may be collected in the manner provided in Section 11.3 hereof.
- 11.3 Default in Payment of Assessments for Common Expenses. Assessments and installments thereof not paid within ten (10) days from the day when they are due shall bear interest at the highest lawful rate from the date due until paid. In addition to the above stated interest, the Association shall charge an administrative late fee in an amount not to exceed the highest amount provided for in the Act (as amended from time to time) on Assessments and installments thereof not paid when due. All payments upon account shall be first applied to interest accrued by the Association, then to any administrative late fee, then to any costs and reasonable attorneys' fees incurred in collection and then to the delinquent Assessment. The foregoing method of applying payments shall be applicable notwithstanding any restrictive endorsement, designation, or instruction placed on or accompanying a payment. The Association has a lien on each Condominium Parcel for any unpaid Assessments or installments thereof, with interest, late fees and for reasonable attorneys' fees and costs incurred by the Association incident to the collection of the Assessment or enforcement of the lien whether suit be brought or not. The lien is effective from and shall relate back to the recording of this Declaration. However, as to Institutional First Mortgagees holding a first mortgage of record, the lien is effective from and after the recording of a claim of lien in the Public Records of the County in which the Condominium Parcel is located, stating the description of the Condominium Parcel, the name of the record Owner, name and address of the Association, the amount due and the due dates. The claim of lien must be executed and acknowledged by an officer or authorized agent of the Association. The claim of lien shall not be released until all sums secured by it (or such other amount as to which the Association shall agree by way of settlement) have been fully paid or until it is barred by law. No such claim of lien shall be effective longer than one (1) year after the claim of lien has been recorded unless, within that time, an action to enforce the lien is commenced. The one (1) year period shall

automatically be extended by any length of time during which the Association is prevented from filing a foreclosure action by an automatic stay resulting from a bankruptcy petition filed by the Unit Owner or any other person claiming an interest in the Condominium Parcel. The claim of lien shall secure (whether or not stated therein) all unpaid Assessments, interest thereon, and costs and attorney's fees which are due and which may accrue subsequent to the recording of the claim of lien and prior to the entry of a certificate of title as well as interest, and all reasonable costs and attorney's fees incurred by the Association incident to the collection process. Upon payment in full, the person making the payment is entitled to a satisfaction of the lien in recordable form. The Association may bring an action in its name to foreclose a lien for unpaid Assessments in the manner a mortgage of real property is foreclosed and may also bring an action at law to recover a money judgment for the unpaid Assessments without waiving any claim of lien. The Association is entitled to recover its reasonable attorneys' fees incurred in either a lien foreclosure action or an action to recover a money judgment for unpaid Assessments. As an additional right and remedy of the Association, upon default in the payment of Assessments as aforesaid and after thirty (30) days' prior written notice to the applicable Unit Owner, the Association may declare the Assessment installments for the remainder of the budget year to be accelerated (or if acceleration to such extent is prohibited by the Act, then the Association may declare Assessments to the maximum extent permitted under the Act to be accelerated) and such amount shall thereupon be due and payable on the date the claim of lien is filed. Such accelerated Assessments shall include the amounts due for the remainder of the budget year in which the claim of lien was filed. In the event the amount of such installments changes during the period for which Assessments were accelerated, the Unit Owner or the Association, as appropriate, shall be obligated to pay or reimburse to the other the amount of increase or decrease within ten (10) days of same taking effect.

- 11.4 Notice of Intention to Foreclose Lien. No foreclosure judgment may be entered until at least thirty (30) days after the Association gives written notice to the Unit Owner of its intention to foreclose its lien to collect the unpaid Assessments. If this notice is not given at least thirty (30) days before the foreclosure action is filed, and if the unpaid Assessments, including those coming due after the claim of lien is recorded, are paid before the entry of a final judgment of foreclosure, the Association shall not recover attorneys' fees or costs. The notice must be given by personal delivery of the notice to the Unit Owner or by certified or registered mail, return receipt requested, addressed to the Unit Owner at the last known address, and upon such mailing, the notice shall be deemed to have been given and the court shall proceed with the foreclosure action and may award attorneys' fees and costs as permitted by law. The notice requirements of this subsection are satisfied if the Unit Owner records a Notice of Contest of Lien as provided in the Act.
- 11.5 Appointment of Receiver to Collect Rental. If the Unit Owner remains in possession of the Unit after a foreclosure judgment has been entered, the court, in its discretion, may require the Unit Owner to pay a reasonable rental amount for

the Unit. If the Unit is rented or leased during the pendency of the foreclosure action, the Association is entitled to the appointment of a receiver to collect the rent. The expenses of the receiver shall be paid by the party which does not prevail in the foreclosure action.

11.6 Institutional First Mortgagee. An Institutional First Mortgagee acquiring title to a Condominium Parcel as a result of foreclosure, or a deed in lieu of foreclosure, may not, during the period of its ownership of such parcel, whether or not such parcel is unoccupied, be excused from the payment of some or all of the Common Expenses coming due during the period of such ownership. The liability of an Institutional First Mortgagee, or its successor or assignees, who acquires title to a Unit by foreclosure or by deed in lieu of foreclosure for the unpaid Assessments (or installments thereof) that became due prior to the Institutional First Mortgagee's acquisition of title is limited to the lesser of:

- (a) The Unit's unpaid Common Expenses and regular periodic Assessments which accrued or came due during the six (6) months immediately preceding the acquisition of title and for which payment in full has not been received by the Association; or
- (b) One percent (1%) of the original mortgage debt.

If any unpaid share of Common Expenses or Assessments or other charges is extinguished by foreclosure of a superior lien or by a deed in lieu of foreclosure thereof, the unpaid share of common expenses or assessments are Common Expenses collectible from all of the Unit Owners, including such acquirer, and such acquirer's successors and assigns. An Institutional First Mortgagee acquiring title to a Condominium Parcel as a result of foreclosure or deed in lieu of foreclosure may not, during the period of its ownership of such parcel, whether or not such parcel is unoccupied, be excused from the payment of some or all of the Common Expenses coming due during the period of such ownership. As to a Unit acquired by foreclosure, the limitations set forth in clauses (a) and (b) above shall not apply unless the Institutional First Mortgagee joined the Association as a defendant in the foreclosure action. Joinder of the Association, however, is not required if, on the date the complaint is filed, the Association was dissolved or did not maintain an office or agent for service of process at a location which was known to or reasonably discoverable by that Institutional First Mortgagee.

11.7 Guarantee of Assessments by Developer. Developer guarantees to each Unit Owner that for the period commencing on the date of recording of the Declaration until one (1) month following the date on which the closing on the purchase and sale of the first Unit in the Condominium occurs (the "Guarantee Period"), the monthly Assessment for Common Expenses for a Unit will not exceed the monthly Assessment amount for that particular Unit as expressly stated in the prospectus for the Condominium for Units sold by the Developer. During the Guarantee Period, the Developer shall be excused from the payment of the Developer's share of the Common Expenses for Units owned by the Developer;

provided, however, if, at any time during the Guarantee Period, the funds collected from Unit Owner Assessments at the guaranteed level are not sufficient to provide payment, on a timely basis, of all Common Expenses, including the full funding of the reserves, unless the funding of reserves has been properly waived, the Developer shall advance money to the Association at the time such payments are due so as to eliminate any deficit in the funds. For purposes of this subsection, income to the Association other than Assessments (as defined herein and in the Act) shall not be taken into account when determining the deficits to be funded by the Developer. The Developer shall have the option of extending the Guarantee Period by twenty-four (24) or more extensions of one (1) month each, in Developer's sole discretion, on the same terms, or paying the share of Common Expenses and Assessments attributable to the Units it is then offering for sale. No funds receivable from Unit purchasers or Unit Owners payable to the Association or collected by the Developer on behalf of the Association, other than regular periodic Assessments for Common Expenses as provided in this Declaration and disclosed in the Estimated Operating Budget of the Association, shall be used for the payment of Common Expenses during any period in which the Developer is excused from payment of Assessments. This restriction shall apply to funds including, but not limited to, capital contributions or start-up funds collected from Unit purchasers at closing.

Notwithstanding the above and as provided in Section 718.116(9)(a)(2) of the Act, in the event of an Extraordinary Financial Event (hereinafter defined), the cost necessary to effect restoration shall be assessed against all Unit Owners owning Units on the date of such Extraordinary Financial Event, and their successors and assigns, including the Developer (with respect to Units owned by the Developer). As used in this subsection, an "Extraordinary Financial Event" shall mean a casualty loss affecting the Condominium resulting from a natural disaster or Act of God, which is not covered by insurance proceeds from the insurance maintained by the Association as required by Section 718.111(11)(a) of the Act.

11.8 Certificate of Unpaid Assessments. Within fifteen (15) days after written request by a Unit Owner or mortgagee of a Unit, the Association shall provide a certificate stating whether all Assessments and other moneys owed to the Association by the Unit Owner with respect to his or her Unit have been paid. Any person other than the Unit Owner who relies upon such certificate shall be protected thereby.

11.9 Installments. Regular Assessments may be collected monthly or quarterly, in advance, at the option of the Association from time to time. Initially, Assessments will be collected monthly.

12. Insurance. Insurance covering the Condominium Property and the Association Property shall be governed by the following provisions:

12.1 Purchase, Custody and Payment.

- (a) Purchase. All insurance policies described herein covering portions of the Condominium Property and Association Property shall be purchased by the Association and shall be issued by an insurance company authorized to do business in Florida.
- (b) Mortgagees. No policy or insurance coverage shall impair the security of the Primary Institutional First Mortgagee without its consent.
- (c) Named Insured. The named insured shall be the Association, individually, and as agent for Owners of Units covered by the policy, without naming them, and as agent for their mortgagees, without naming them. The Unit Owners and their mortgagees shall be deemed additional insureds.
- (d) Custody of Policies and Payment of Proceeds. All policies shall provide that payments for losses made by the insurer shall be paid to the Insurance Trustee, hereinafter defined in Section 12.11, (if appointed), and all policies and endorsements thereto shall be deposited with the Insurance Trustee (if appointed).
- (e) Copies to Mortgagees. One copy of each insurance policy, or a certificate evidencing such policy, and all endorsements thereto, shall be furnished by the Association upon request to each Institutional First Mortgagee who holds a mortgage upon a Unit covered by the policy. Copies or certificates shall be furnished not less than ten (10) days prior to the beginning of the term of the policy, or not less than ten (10) days prior to the expiration of each preceding policy that is being renewed or replaced, as appropriate.
- (f) Personal Property and Liability. Except as specifically provided herein or by the Act, the Association shall not be responsible to Unit Owners to obtain insurance coverage upon the property lying within the boundaries of their respective Units (or within any Limited Common Elements appurtenant thereto), including, but not limited to, their personal property, and for their personal liability and living expense and for any other risks not otherwise insured in accordance herewith.

12.2 Coverage. The Association shall use its best efforts to maintain insurance covering the following:

- (a) Casualty. The Building (including the Limited Common Elements and the Common Elements) and all fixtures, installations or additions comprising that part of the Building within the boundaries of the Units and required by the Act to be insured under the Association's policy(ies), but excluding all furniture, furnishings, floor coverings, wall coverings and ceiling coverings or other personal property owned, supplied or installed by Unit Owners or tenants of Unit Owners, and also excluding hurricane shutters, Unit floor coverings, wall coverings, or ceiling coverings and the following equipment if it is located within a Unit (or Limited Common

Elements appurtenant thereto) and such equipment as the Unit Owner is required to repair or replace; electrical fixtures, appliances, air conditioner or heating equipment, water heaters, built-in cabinets, personal property, fixture, appliance or equipment permitted to be excluded from the Condominium's insurance policy pursuant to the Act, as same may be amended or renumbered from time to time and all Improvements located on the Common Elements from time to time, together with all fixtures, building service equipment, personal property and supplies constituting the Common Elements or owned by the Association (collectively the "Insured Property"), shall be insured in an amount not less than 100% of the full insurable replacement value thereof, excluding foundation and excavation costs. Such policies may contain reasonable deductible provisions as determined by the Board of Directors of the Association. Such coverage shall afford protection against:

- (i) Loss or Damage by Fire and Other Hazards covered by a standard extended coverage endorsement; and
 - (ii) Such Other Risk as from time to time are customarily covered with respect to Building and improvements similar to the Insured Property in construction, location and use, including, but not limited to, vandalism and malicious mischief.
- (b) Liability. Comprehensive general public liability and automobile liability insurance covering loss or damage resulting from accidents or occurrences on or about or in connection with the Insured Property or adjoining driveways and walkways, or any work, matters or things related to the Insured Property, with such coverage as shall be required by the Board of Directors of the Association, but with combined single limit liability of not less than \$1,000,000 for each accident or occurrence, \$100,000 per person and \$100,000 property damage for each accident or occurrence, and with a cross liability endorsement to cover liabilities of the Unit Owners as a group to any Unit Owner, and vice versa. The Association may also obtain and maintain liability insurance for its directors and officers and for the benefit of the Association's employees.
- (c) Workers' Compensation. The Association shall obtain workers' compensation and other mandatory insurance, when applicable.
- (d) Flood Insurance. The Association shall obtain flood insurance if required by the Primary Institutional First Mortgagee or if the Association so elects.
- (e) Fidelity Insurance. The Association shall obtain and maintain adequate fidelity bonding of all persons who control or disburse funds of the Association, including but not limited to the President, Secretary and Treasurer of the Association, in an amount not less than the minimum sum required by the Act.

- (f) Association Property. Appropriate additional policy provisions, policies or endorsements extending the applicable portions of the coverage described above to all Association Property, where such coverage is available.
- (g) Such Other Insurance. The Board of Directors of the Association shall obtain such other policies of insurance as the Board may determine from time to time to be desirable.

When appropriate and obtainable, each of the foregoing policies shall waive the insurer's right to: (i) subrogation against the Association and against the Unit Owners individually and as a group, (ii) pay only a fraction of any loss in the event of co-insurance or if other insurance carriers have issued coverage upon the same risk, and (iii) avoid liability for a loss that is caused by an act of the Board of Directors of the Association, a member of the Board of Directors of the Association, one or more Unit Owners or as a result of contractual undertakings. Additionally, each policy shall provide that any insurance trust agreement will be recognized, that the insurance provided shall not be prejudiced by any act or omissions of individual Unit Owners that are not under the control of the Association, and that the policy shall be primary, even if a Unit Owner has other insurance that covers the same loss.

- 12.3 Additional Provisions. All policies of insurance shall provide that such policies may not be cancelled or substantially modified without at least thirty (30) days' prior written notice to all of the named insureds, including all mortgagees of Units. Prior to obtaining any policy of casualty insurance or any renewal thereof, the Board of Directors shall obtain an appraisal from a fire insurance company, or other competent appraiser, of the full insurable replacement value of the Insured Property (exclusive of foundations), without deduction for depreciation, for the purpose of determining the amount of insurance to be effected pursuant to this Section.
- 12.4 Premiums. Premiums (or allocable shares thereof) upon insurance policies purchased by the Association shall be paid by the Association as a Common Expense. Premiums may be financed in such manner as the Board of Directors deems appropriate.
- 12.5 Unit Owner Coverage. Each Unit Owner shall obtain and maintain at all times, individual casualty and general liability policies insuring the property lying within the boundaries of their Unit and for their personal liability arising in the use of their own Unit and other areas of the Common Elements for which they have exclusive use. Each Unit Owners' insurance policy shall provide that the coverage afforded by such policy is excess over the amount recoverable under any other policy covering the same property, without the rights of subrogation against the Association. Each Unit Owner shall, upon the written request of the Association, provide the Association with a copy of a binder, a policy or other proof satisfactory to the Association of said insurance coverage.

- 12.6 Insurance Trustee; Share of Proceeds. All insurance policies obtained by or on behalf of the Association shall be for the benefit of the Association, the Unit Owners and their mortgagees, as their respective interests may appear, and shall provide that all proceeds covering property losses shall be paid to the Association or to the Insurance Trustee (if one exists) which may, but need not, be designated by the Board of Directors. References herein to the Insurance Trustee shall be deemed to apply to the Board of Directors if it elects to serve such functions pursuant to subsection 12.11 hereof. The Insurance Trustee shall not be liable for payment of premiums, nor for the renewal or the sufficiency of policies, nor for the failure to collect any insurance proceeds. The duty of the Insurance Trustee shall be to receive such proceeds as are paid and to hold the same in trust for the purposes elsewhere stated herein, and for the benefit of the Unit Owners and their respective mortgagees in the following shares, but such shares need not be set forth on the records of the Insurance Trustee:
- (a) Insured Property. Proceeds on account of damage to the Insured Property shall be held in undivided shares for each Unit Owner, such shares being the same as the undivided shares in the Common Elements appurtenant to each Unit, provided that if the Insured Property so damaged includes property lying within the boundaries of specific Units and/or Limited Common Elements appurtenant thereto, that portion of the proceeds allocable to such property shall be held as if that portion of the Insured Property were Optional Property as described in paragraph (b) below.
 - (b) Optional Property. Proceeds on account of damage solely to Units and/or certain portions or all of the contents thereof not included in the Insured Property, all as determined by the Association in its sole discretion (collectively, the "Optional Property"), if any are collected by reason of optional insurance which the Association elects to carry thereon (as contemplated herein), shall be held for the benefit of Owners of Units or other portions of the Optional Property damaged in proportion to the cost of repairing the damage suffered by each such affected Owner, which cost and allocation shall be determined in the sole discretion of the Association.
 - (c) Mortgagees. No mortgagee shall have any right to determine or participate in the determination as to whether or not any damaged property shall be reconstructed or repaired, and no mortgagee shall have any right to apply or have applied to the reduction of a mortgage debt any insurance proceeds, except for actual distributions thereof made to the Unit Owner and mortgagee pursuant to the provisions of this Declaration.
- 12.7 Distribution of Proceeds. Proceeds of insurance policies received by the Insurance Trustee shall be distributed to or for the benefit of the beneficial owners thereof in the following manner:

- (a) Expenses of the Trustee. All expenses of the Insurance Trustee shall be first paid or provision for such payment shall be made therefor.
 - (b) Reconstruction or Repair. If the damaged property for which the proceeds are paid is to be repaired or reconstructed, the remaining proceeds shall be paid to defray the cost thereof as elsewhere provided herein. Any proceeds remaining after defraying such costs shall be distributed to the beneficial owners thereof, remittances to Unit Owners and their mortgagees being payable jointly to them.
 - (c) Failure to Reconstruct or Repair. If it is determined in the manner elsewhere provided that the damaged property for which the proceeds are paid shall not be reconstructed or repaired, the remaining proceeds shall be allocated among the beneficial owners as provided in subsection 12.6 above, and distributed first to all Institutional First Mortgagees in an amount sufficient to pay off their mortgages, and the balance, if any, to the beneficial owners.
 - (d) Certificate. In making distributions to Unit Owners and their mortgagees, the Insurance Trustee (if appointed) may rely upon a certificate of the Association made by its President and Secretary as to the names of the Unit Owners and their mortgagees and their respective shares of the distribution.
- 12.8 Association as Agent. The Association is hereby irrevocably appointed as agent and attorney-in-fact for each Unit Owner and for each owner of a mortgage or other lien upon a Unit and for each owner of any other interest in the Condominium Property to adjust all claims arising under insurance policies purchased by the Association and to execute and deliver releases upon the payment of claims.
- 12.9 Unit Owners' Personal Coverage. Unless the Association elects otherwise, the insurance purchased by the Association shall not cover claims against an Owner due to accidents occurring within his Unit (or Limited Common Elements appurtenant thereto), nor casualty or theft loss to the contents of an Owner's Unit or Limited Common Elements appurtenant thereto. It shall be the obligation of the individual Unit Owner, if such Owner so desires, to purchase and pay for insurance as to all risks not covered by insurance carried by the Association.
- 12.10 Benefit of Mortgagees. Certain provisions in this Section 12 entitled "Insurance" are for the benefit of mortgagees of Units and may be enforced by such mortgagees.
- 12.11 Insurance Trustee Optional. The Board of Directors of the Association shall have the option in its discretion of appointing an insurance trustee ("Insurance Trustee") hereunder. If the Association fails or elects not to appoint such Insurance Trustee, the Association will perform directly all obligations imposed

upon such Insurance Trustee by this Declaration. Fees and expenses of any Insurance Trustee are Common Expenses.

13. **Reconstruction or Repair After Fire or Other Casualty.**

13.1 **Determination to Reconstruct or Repair.** Subject to the immediately following sub-paragraph, in the event of damage to or destruction of the Insured Property (and the Optional Property, if insurance has been obtained by the Association with respect thereto) as a result of fire or other casualty, the Board of Directors shall arrange for the prompt repair and restoration of the Insured Property (and the Optional Property, if insurance has been obtained by the Association with respect thereto) and the Insurance Trustee (if appointed) shall disburse the proceeds of all insurance policies to the contractors engaged in such repair and restoration in appropriate progress payments.

If 75% or more of the Insured Property (and the Optional Property, if insurance has been obtained by the Association with respect thereto) is substantially damaged or destroyed and if Unit Owners owning 80% of the applicable interests in the Common Elements duly and promptly resolve not to proceed with the repair or restoration thereof and at least 51% of Institutional First Mortgagees approve such resolution, the Condominium Property will not be repaired and shall be subject to an action for partition instituted by the Association, any Unit Owner, mortgagee or lienor, as if the Condominium Property were owned in common, in which event the net proceeds of insurance resulting from such damage or destruction shall be divided among all the Unit Owners in proportion to their respective interests in the Common Elements (with respect to proceeds held for damage to the Insured Property other than that portion of the Insured Property lying within the boundaries of the Unit), and among affected Unit Owners in proportion to the damage suffered by each such affected Unit Owner, as determined in the sole discretion of the Association (with respect to proceeds held for damage to the Optional Property, if any, and/or that portion of the Insured Property lying within the boundaries of the Unit); provided, however, that no payment shall be made to a Unit Owner until there has first been paid off out of his share of such fund all mortgages and liens on his Unit in the order of priority of such mortgages and liens.

Whenever in this section the words "promptly repair" are used, it shall mean that repairs are to begin not more than sixty (60) days from the date the Insurance Trustee (if appointed) notifies the Board of Directors and Unit Owners that it holds proceeds of insurance on account of such damage or destruction sufficient to pay the estimated cost of such work, or not more than ninety (90) days after the Insurance Trustee (if appointed) notifies the Board of Directors and the Unit Owners that such proceeds of insurance are insufficient to pay the estimated costs of such work, subject to the issuance of necessary permits for such work. The Insurance Trustee (if appointed) may rely upon a certificate of the Association made by its President and Secretary to determine whether or not the damaged property is to be reconstructed or repaired.

13.2 Plans and Specifications. Any reconstruction or repair must be made substantially in accordance with the plans and specifications for the original Improvements and then applicable building and other codes; or if not, then in accordance with the plans and specifications approved by the Board of Directors of the Association and then applicable building and other codes, and if the damaged property which is to be altered are the Building or the Optional Property, by the Owners of not less than 80% of the applicable interests in the Common Elements, as well as the Owners of all Units and other portions of the Optional Property (and their respective mortgagees) the plans for which are to be altered.

13.3 Special Responsibilities.

- (a) Special Responsibility. If the damage is only to those parts of the Optional Property for which the responsibility of maintenance and repair is that of the respective Unit Owners, then the Unit Owners shall be responsible for all necessary reconstruction and repair, which shall be effected promptly and in accordance with guidelines' established by the Board of Directors (unless insurance proceeds are held by the Association with respect thereto by reason of the purchase of optional insurance thereon, in which case the Association shall have the responsibility to reconstruct and repair the damaged Optional Property, provided the respective Unit Owners shall be individually responsible for any amount by which the cost of such repair or reconstruction exceeds the insurance proceeds held for such repair or reconstruction on a Unit by Unit basis, as determined in the sole discretion of the Association). In all other instances, the responsibility for all necessary reconstruction and repair shall be that of the Association.
- (b) Disbursement. The proceeds of insurance collected on account of a casualty, and the sums collected from Unit Owners on account of such casualty, shall constitute a construction fund which shall be disbursed in payment of the costs of reconstruction and repair in the following manner and order:
- (i) Association - Lesser Damage. If the amount of the estimated costs of reconstruction and repair which are the responsibility of the Association is less than \$100,000, then the construction fund shall be disbursed in payment of such costs upon the order of the Board of Directors of the Association; provided, however, that upon request to the Insurance Trustee (if appointed) by an Institutional First Mortgagee which is a beneficiary of an insurance policy, the proceeds of which are included in the construction fund, such fund shall be disbursed in the manner provided below for the reconstruction and repair of major damage.

- (ii) Association - Major Damage. If the amount of the estimated costs of reconstruction and repair which are the responsibility of the Association is more than \$100,000, then the construction fund shall be disbursed in payment of such costs in the manner contemplated by subparagraph (i) above, but then only upon the further approval of an architect or engineer qualified to practice in Florida and employed by the Association to supervise the work.
- (iii) Unit Owners. If there is a balance of insurance proceeds after payment of all costs of reconstruction and repair that are the responsibility of the Association, this balance may be used by the Association to effect repairs to the Optional Property (if not insured or if under-insured), or may be distributed to Owners of the Optional Property who have the responsibility for reconstruction and repair thereof. The distribution shall be in the proportion that the estimated cost of reconstruction and repair of such damage to each affected Unit owner bears to the total of such estimated costs to all affected Unit Owners, as determined by the Board; provided, however, that no Unit Owner shall be paid an amount in excess of the estimated costs of repair for his portion of the Optional Property. All proceeds must be used to effect repairs to the Optional Property, and if insufficient to complete such repairs, the Owners shall pay the deficit with respect to their portion of the Optional Property and shall promptly effect the repairs. Any balance remaining after such repairs have been effected shall be distributed to the affected Unit Owners and their mortgagees jointly as elsewhere herein contemplated.
- (iv) Surplus. It shall be presumed that the first monies disbursed in payment of costs of reconstruction and repair shall be from insurance proceeds. If there is a balance in a construction fund after payment of all costs relating to the reconstruction and repair for which the fund is established, such balance shall be distributed to the beneficial owners of the fund in the manner elsewhere stated; except, however, that the part of a distribution to an Owner which is not in excess of Assessments paid by such Owner into the construction fund shall not be made payable jointly to any mortgagee.
- (v) Certificate. Notwithstanding the provisions herein, the Insurance Trustee (if appointed) shall not be required to determine whether or not sums paid by Unit Owners upon Assessments shall be deposited by the Association with the Insurance Trustee (if appointed), nor to determine whether the disbursements from the construction fund are to be made upon the order of the Association alone or upon the additional approval of an architect, engineer or otherwise, nor whether a disbursement is to be made from the

construction fund, nor to determine whether surplus funds to be distributed are less than the Assessments paid by Owners, nor to determine the payees nor the amounts to be paid. The Insurance Trustee (if appointed) may rely upon a certificate of the Association, made by its President and Secretary, as to any or all of such matters and stating that the sums to be paid are due and properly payable, and stating the names of the payees and the amounts to be paid.

- 13.4 Assessments. If the proceeds of the insurance are not sufficient to defray the estimated costs of reconstruction and repair to be effected by the Association, or if at any time during reconstruction and repair, or upon completion of reconstruction and repair, the funds for the payment of the costs of reconstruction and repair are insufficient, Assessments shall be made against the Unit Owners in sufficient amounts to provide funds for the payment of such costs. Such Assessments on account of damage to the Insured Property shall be in proportion to all of the Owners' respective shares in the Common Elements. Costs on account of damage to the Optional Property shall be charged to each Owner in proportion to the cost of repairing the damage suffered by each Owner thereof, as determined by the Association.
- 13.5 Benefit of Mortgagees. Certain provisions in this Section 13 are for the benefit of mortgagees of Units and may be enforced by any of them.

14. Condemnation.

- 14.1 Deposit of Awards with Insurance Trustee. The taking of portions of the Condominium Property by the exercise of the power of eminent domain shall be deemed to be a casualty, and the awards for that taking shall be deemed to be proceeds from insurance on account of the casualty and shall be deposited with the Insurance Trustee (if appointed). Even though the awards may be payable to Unit Owners, the Unit Owners shall deposit the awards with the Insurance Trustee (if appointed); and in the event of failure to do so, in the discretion of the Board of Directors of the Association, a special charge shall be made against a defaulting Unit Owner in the amount of his award, or the amount of that award shall be set off against the sums hereafter made payable to that Owner, or the Board shall have the right to proceed in a court of equity to require performance and/or sue at law for damages.
- 14.2 Determination Whether to Continue Condominium. Whether the Condominium will be continued after condemnation will be determined in the manner provided for determining whether damaged property will be reconstructed and repaired after casualty. For this purpose, the taking by eminent domain also shall be deemed to be a casualty.
- 14.3 Disbursement of Funds. If the Condominium is terminated after condemnation, the proceeds of the awards and Special Assessments will be deemed to be

insurance proceeds and shall be owned and distributed in the manner provided with respect to the ownership and distribution of insurance proceeds if the Condominium is terminated after a casualty. If the Condominium is not terminated after condemnation, the size of the Condominium will be reduced and the property damaged by the taking will be made usable in the manner provided below. The proceeds of the awards and Special Assessments shall be used for these purposes and shall be disbursed in the manner provided for disbursement of funds by the Insurance Trustee (if appointed) after a casualty, or as elsewhere in this Section 14 specifically provided.

14.4 Unit Reduced But Habitable. If the taking reduces the size of a Unit and the remaining portion of the Unit can be made habitable (in the sole opinion and discretion of the Association), the award for the taking of a portion of the Unit shall be used for the following purposes in the order stated and the following changes shall be made to the Condominium:

- (a) Restoration of Unit. The Unit shall be made habitable. If the cost of the restoration exceeds the amount of the award, the additional funds required shall be charged against the Owner of the Unit. The Association shall have the right to collect and enforce such costs and charges as elsewhere provided in accordance with this Declaration, pursuant to subsection 17.2 below and applicable law.
- (b) Distribution of Surplus. The balance of the award in respect of the Unit, if any, shall be distributed to the Owner of the Unit and to each mortgagee of the Unit, the remittance being made payable jointly to the Owner and such mortgagees.
- (c) Adjustment of Shares in Common Elements. If the floor area of the Unit is reduced by the taking, the percentage representing the share in the Common Elements and of the Common Expenses and Common Surplus appurtenant to the Unit shall be reduced by multiplying the percentage of the applicable Unit prior to reduction by a fraction, the numerator of which shall be the area in square feet of the Unit after the taking and the denominator of which shall be the area in square feet of the Unit before the taking. The shares of all Unit Owners in the Common Elements, Common Expenses and Common Surplus shall be restated as follows:
 - (i) add the total of all percentages of all Units after reduction as aforesaid (the "Remaining Percentage Balance"); and
 - (ii) divide each percentage for each Unit after reduction as aforesaid by the Remaining Percentage Balance.

The result of such division for each Unit shall be the adjusted percentage for such Unit.

14.5 Unit Made Uninhabitable. If the taking is of the entire Unit or so reduces the size of a Unit that it cannot be made habitable (in the sole opinion and discretion of the Association), the award for the taking of the Unit shall be used for the following purposes in the order stated and the following changes shall be made to the Condominium:

- (a) Payment of Award. The awards shall be paid first to the applicable Institutional First Mortgagees in amounts sufficient to pay off their mortgages in connection with each Unit which is not so habitable; second, to the Association for any due and unpaid Assessments; third, jointly to the affected Unit Owners and other mortgagees of their Units. In no event shall the total of such distributions in respect of a specific Unit exceed the market value of such Unit immediately prior to the taking. The balance, if any, shall be applied to repairing and replacing the Common Elements.
- (b) Addition to Common Elements. The remaining portion of the Unit, if any, shall become part of the Common Elements and shall be placed in a condition allowing, to the extent possible, for use by all of the Unit Owners in the manner approved by the Board of Directors of the Association; provided that if the cost of the work therefor shall exceed the balance of the fund from the award for the taking, such work shall be approved in the manner elsewhere required for capital improvements to the Common Elements.
- (c) Adjustment of Shares. The shares in the Common Elements, Common Expenses and Common Surplus appurtenant to the Units that continue as part of the Condominium shall be adjusted to distribute the shares in the Common Elements, Common Expenses and Common Surplus among the reduced number of Unit Owners (and among reduced Units). This shall be effected by restating the shares of continuing Unit Owners as follows:
 - (i) add the total of all percentages of all Units of continuing Owners prior to this adjustment, but after any adjustments made necessary by subsection 14.4(c) hereof (the "Percentage Balance"); and
 - (ii) divide the percentage of each Unit of a continuing Owner prior to this adjustment, but after any adjustments made necessary by subsection 14.4(c) hereof, by the Percentage Balance.

The result of such division for each Unit shall be the adjusted percentage for such Unit.

- (d) Assessments. If the balance of the award (after payments to the Unit Owners and such Owner's mortgagees as above provided) for the taking is not sufficient to alter the remaining portion of the Unit for use as a part of the Common Elements, the additional funds required for such purposes shall be raised by Assessments against all of the Unit Owners who will

continue as Owners of Units after the changes in the Condominium effected by the taking. The Assessments shall be made in proportion to the applicable percentage shares of those Owners after all adjustments to such shares effected pursuant hereto by reason of the taking.

- (e) Arbitration. If the market value of a Unit prior to the taking cannot be determined by agreement between the Unit Owner and mortgagees of the Unit and the Association within 30 days after notice of a dispute by any affected party, such value shall be determined by arbitration in accordance with the then existing rules of the American Arbitration Association, except that the arbitrators shall be two appraisers appointed by the American Arbitration Association who shall base their determination upon an average of their appraisals of the Unit. A judgment upon the decision rendered by the arbitrators may be entered in any court of competent jurisdiction in accordance with the Florida Arbitration Code. The cost of arbitration proceedings shall be assessed against all Unit Owners, including Owners who will not continue to be Owners after the taking, in proportion to the applicable percentage shares of such Owners as they exist prior to the adjustments to such shares effected pursuant hereto by reason of the taking.

14.6 Taking of Common Elements. Awards for the taking of Common Elements shall be used to render the remaining portion of the Common Elements usable in the manner approved by the Board of Directors of the Association; provided, that if the cost of such work shall exceed the balance of the funds from the awards for the taking, the work shall be approved in the manner elsewhere required for capital improvements to the Common Elements. The balance of the awards for the taking of Common Elements, if any, shall be distributed to the Unit Owners in the shares in which they own the Common Elements after adjustments to these shares are effected pursuant hereto by reason of the taking. If there is a mortgage on a Unit, the distribution shall be paid jointly to the Owner and the mortgagees of the Unit.

14.7 Amendment of Declaration. The changes in Units, in the Common Elements and in the ownership of the Common Elements and share in the Common Expenses and Common Surplus that are effected by the taking shall be evidenced by an amendment to this Declaration of Condominium that is only required to be approved by, and executed upon the direction of, a majority of all Directors of the Association.

15. Occupancy and Use Restrictions. In order to provide for congenial occupancy and use of the Condominium Property and for the protection of the values of the Units, the use of the Condominium Property shall be restricted to and shall be in accordance with the following provisions:

15.1 Occupancy. Each Unit shall be used as a residence only, except as otherwise herein provided, and the maximum permanent occupants and overnight guests

shall be no more than legally permitted, all in accordance with applicable municipal, county and state codes, ordinances and regulations. No trade, business, profession or any other type of commercial activity shall be carried on in the Units; provided, however, an Owner may use a room within a Unit as an office for conducting personal business if such personal business does not require contact at the Unit with customers or clientele of the Owner, nor be of such a pervasive nature as to dominate the residential character of the occupancy of such Unit. Any such personal office use shall not be deemed a commercial activity in violation of this Paragraph 15.1. Such personal business use must, nonetheless, comply with any applicable governmental regulation.

- 15.2 Children. Children shall be permitted to be occupants of Units, but are restricted in certain activities. See the Rules and Regulations attached to the By-Laws as Schedule "RR" thereto.
- 15.3 Pets. Not more than two (2) domestic pets (limited to either dogs, cats or other common household pets) may be kept in a Unit, provided said pets: (i) are not kept, bred, or maintained for any commercial purpose; (ii) are not a nuisance or annoyance to neighbors; and (iii) are not left unattended on balconies or outside the Units. All pets must be registered and approved by the Board, which approval may be given or withheld in the sole discretion of the Board. No pit bulls or other breeds of pets considered to be dangerous by the Board shall be permitted. Unit Owners must pick up all solid wastes of their pets and dispose of such waste appropriately. All pets, including cats, must be leashed at all times when outside the Unit. Pets may not be kept in or on a Limited Common Element, nor be walked through or kept in any pool area or any other recreational facilities of the Condominium Property. Neither the Developer, Board of Directors, nor the Association shall be liable for any personal injury, death or property damage resulting from a violation of this subsection, and any occupant of a Unit committing such a violation shall fully indemnify and hold harmless the Developer, the Board of Directors, the Association, and each Unit Owner in such regard. Without limiting the generality of Section 17 hereof, a violation of the provisions of this subsection shall entitle the Association to all of its rights and remedies, including, but not limited to, the right to fine Unit Owners (as provided in the By-Laws and Rules and Regulations) and/or to require, through order of the Board, any pet to be permanently removed from the Condominium Property.
- 15.4 Alterations. Without limiting the generality of Section 8 hereof and except as otherwise provided in this Declaration, no Unit Owner shall cause or allow improvements or changes to any Limited Common Elements or Common Elements, including, but not limited to, painting or other decorating of any nature, installing any electrical wiring, machinery, pools, whirlpools or saunas or air-conditioning units or in any manner changing the appearance or impairing the structural soundness of any portion of the Building without obtaining the prior written consent of the Association. Curtains, drapes or other window coverings (or linings thereof) which face the exterior windows or glass doors of Units shall be white or off-white in color, and shall be subject to disapproval by the

Association, in which case they shall be removed and replaced with acceptable items.

- 15.5 Use of Common Elements, Limited Common Elements and Association Property. The Common Elements, Limited Common Elements and Association Property shall be used only for furnishing of the services and facilities for which they are reasonably suited and which are incident to the use and occupancy of Units. All Residential Limited Common Elements shall be for the exclusive use of residential Units and shall only be used for services and facilities for which they are reasonably suited and for their intended use. All posted rules and regulations on common Elements, Limited Common Elements and Association Property shall be strictly followed by all Owners, and the Owner's guests, tenants and invitees.
- 15.6 Use of Parking Spaces. Parking spaces, whether on the Association Property or Common Elements or Developer owned property, or any adjoining property owner's property pursuant to a cross-easement agreement, shall be utilized solely for the parking of motor vehicles. No parking space shall be permitted to be used at any time for any purpose which does not permit the parking of a motor vehicle therein.
- 15.7 Use of Parking Garages. Parking garages shall be utilized solely for the parking of motor vehicles and for miscellaneous storage but no parking garage shall be used or converted for use for a business or other activity. No parking garage shall be permitted to be used at any time for any purpose which does not permit the parking of a motor vehicle therein. Parking garage doors shall be kept closed when not being used for the purposes of ingress and egress. The maintenance of the interior of any garage appurtenant to a Unit, as well as the insurance of its contents and any mechanical or automatic garage door opener, shall be the sole responsibility of the Owner of the Unit to which the garage is appurtenant. Any required structural or exterior repairs, including the garage door, required thereto shall be the responsibility of the Unit Owner and the cost thereof shall **not** be deemed a Common Expense.
- 15.8 Use of Storage Spaces. Storage Spaces shall be utilized solely for miscellaneous storage and shall not be used or converted for use for a business or other activity. No storage space shall be used in connection with any unlawful activity. The maintenance of the interior of any Storage Space, as well as the insurance of its contents shall be the sole responsibility of the Owner of the Storage Space. Any required structural or exterior repairs shall be the responsibility of the Association and the cost thereof shall be deemed a Common Expense.
- 15.9 Nuisances. No nuisances (as defined by the Association) shall be allowed on the Condominium Property or Association Property, nor shall any use or practice be allowed which is a source of annoyance to Owners or occupants of Units or which interferes with the peaceful possession or proper use of the Condominium Property and/or Association Property by its Owners, members, or occupants. No activity specifically permitted by this Declaration shall be deemed a nuisance. In

the event a dispute or question as to what may be or become a nuisance, such dispute or question shall be submitted to the Board of Directors, which shall render a decision in writing, which decision shall be dispositive of such dispute or question.

- 15.10 No Improper Uses. No improper, offensive, hazardous or unlawful use shall be made of the Condominium Property or Association Property, or any part thereof, and all valid laws, zoning ordinances and regulations of all governmental bodies having jurisdiction thereover shall be observed. Violations of laws, orders, rules, regulations or requirements of any governmental agency having jurisdiction thereover, relating to any portion of the Condominium Property and/or Association Property, shall be corrected by, and at the sole expense of, the party obligated to maintain or repair such portion of the Condominium Property, as elsewhere herein set forth. Notwithstanding the foregoing and any provisions of this Declaration, the Articles of Incorporation or By-Laws, the Association shall not be liable to any person(s) for its failure to enforce the provisions of this subsection 15.7.
- 15.11 Leases. No portion of a Unit (other than an entire Unit) may be leased. All leases of Units shall be in writing and shall be deemed to provide that the Association shall have the right to terminate the lease upon default by the tenant in observing any of the provisions of this Declaration, the Articles of Incorporation and the By-Laws of the Association, Rules and Regulations, or other applicable provisions of any agreement, document or instrument governing the Condominium or administered by the Association. Further, leases shall provide that the Association shall have the right to collect all rental or lease payments due to the Owner and apply same against unpaid Assessments, if, and to the extent that, the Unit Owner is in default in the payment of Assessments. Every lease of a Unit shall specifically provide (or, if it does not, shall be automatically deemed to provide) that a material condition of the lease shall be the tenant's full compliance with the covenants, terms, conditions and restrictions of this Declaration (and all exhibits hereto) and with any and all Rules and Regulations adopted by the Association from time to time and that any failure by the lessee to comply with the terms under the lease shall empower the Association with the right and authority on behalf of the Owner to commence legal proceedings to cause the lessee to be evicted. All Unit Owners shall be jointly and severally liable with their tenants to the Association for any amount which is required by the Association to repair any damage to the Common Elements resulting from acts or omissions of tenants (as determined in the sole discretion of the Association) and to pay any claim for injury or damage to property caused by the negligence of the tenant or for the acts and omissions of the tenant(s) which constitute a violation of, or non-compliance with, the provisions of this Declaration and of any and all Rules and Regulations of the Association. Leases for all Units shall comply with and be subject to the provisions of the Declaration of Condominium, Articles of Incorporation, Rules and Regulations, By-Laws, and the Act, and the provisions of same shall be deemed expressly incorporated into any lease of a Unit. This subsection shall also apply to subleases and assignments and renewals of leases. All leases of Units are

hereby made subordinate to any lien filed by the Association, whether prior or subsequent to such lease. No lease of a Unit shall be for a period of less than seven (7) months and no Unit may be leased in excess of two (2) times a calendar year except for renewals. Notwithstanding the aforesaid, the Association reserves the right to grant an exception to the requirement that no Unit may be leased in excess of two (2) times per calendar year. The Association shall have the right to review and approve all leases and lessees prior to execution of any lease and charge a reasonable administrative fee for the same and require that each lease contain certain uniform provisions, including provisions reflecting the foregoing terms and conditions.

- 15.12 Exterior Improvements. Without limiting the generality of section 8 or subsection 15.4 hereof, but subject to any provision of this Declaration specifically permitting same, no Unit Owner shall cause anything to be affixed or attached to, hung, displayed or placed on the exterior walls, doors, balconies or windows of the Building (including, but not limited to, awnings, signs, screens, window tinting, furniture, fixtures and equipment), without the prior written consent of the Association; except any Unit Owner may display one portable, removable United States flag in a respectful way.
- 15.13 Signs. An Owner (with the exception of the Developer, until the Developer no longer holds Units for sale) shall show no sign, advertisement or notice of any type on the Common Elements, other portions of the Condominium Property, in or upon his or her Unit or in or upon his or her automobile so as to be visible from the Common Elements, or any public way, except as may be previously and specifically approved in writing by the Board. Developer specifically reserves he right to place and maintain identifying or informational signs on any building located on the Condominium Property as well as any signs in connection with its sales activities, until Developer no longer holds Units for sale. The Developer or subsequently the Board may elect to adopt a uniform signage criteria to apply to all Units.
- 15.14 Mitigation of Dampness and Humidity. No Unit Owner shall install, within his or her Unit, or upon the Common Elements or Association Property, non-breathable wall-coverings or low-permeance paints. Additionally, any and all built-in casework, furniture, and or shelving in a Unit must be installed over floor coverings to allow air space and air movement and shall not be installed with backboards flush against any gypsum board wall. Additionally, all Unit Owners, whether or not occupying the Unit, shall periodically run the air conditioning system to maintain the temperature in the Unit, whether or not occupied, at not more than 78°F, to minimize humidity in the Unit. While the foregoing requirement is intended to minimize the potential development of mold, fungi, mildew and other mycotoxins, each Owner understands and agrees that there is no method for completely eliminating the development of mold, fungi, mildew or other mycotoxins. The Developer does not make any representations or warranties regarding the existence or development of mold, fungi, mildew or other mycotoxins and each Owner shall be deemed to waive and expressly release

any such warranty and claim for loss or damages resulting from the existence and/or development of same. In furtherance of the rights of the Association as set forth in the Declaration, in the event that the Association reasonably believes that these provisions are not being complied with, then, the Association shall have the right (but no the obligation) to enter the Unit (without requiring the consent of the Unit Owner or any other party) to turn on the air conditioning system in an effort to cause the temperature of the Unit to be maintained as required (with all utility consumption costs to be paid and assumed by the Unit Owner). To the extent that electric service is not then available to the Unit, the Association shall have the further right, but not the obligation (without requiring the consent of the Unit Owner or any other party), to connect electric service to the Unit (with the costs thereof to be borne by the Unit Owner, or if advanced by the Association, to be promptly reimbursed by the Unit Owner to the Association, with all such costs to be deemed a Special Assessment).

The Association and each Unit Owner shall agree to: (i) regularly inspect the parts of the Condominium that they respectively maintain, and which are visible and accessible without having to first conduct invasive testing, for the existence of mold, mildew, and/or water intrusion (except when the water intrusion is part of the normal functioning of improvements and appliances such as showers, sinks, dishwashers, and other similar appliances and improvements) and/or damage; (ii) upon discovery, immediately repair in a good and workmanlike condition the source of any water intrusion in the parts of the Condominium that they respectively maintain; (iii) remediate or replace any building material located in the parts of the Condominium that they respectively maintain that has absorbed water or moisture as a result of water intrusion; and (iv) promptly and regularly remediate all mold and/or mildew discovered in the parts of the Condominium that they respectively maintain in accordance with current industry-accepted methods.

- 15.15 Removal of Sod and Shrubbery; Alteration of Drainage; Wetlands. Except for the Developer's acts and activities with regard to the development of the Condominium, no sod, top soil, mulch, trees or shrubbery shall be removed from the Condominium Property and no change in the condition of the soil or the level of land of the Condominium Property shall be made which would result in any permanent change in the flow or drainage of surface water within the Condominium without prior written consent of the Board of Directors.
- 15.16 Vehicles. Tractors, motor homes, trailers (with or without wheels), recreational vehicles, boats and other watercraft, boat trailers, campers, camper trailers, and vans and trucks used for commercial purposes shall not be permitted to be on the Condominium Property, except for trucks furnishing goods and services during the daylight hours and except as the Association may designate for such use by appropriate Rules and Regulations. The Association shall have the right to authorize the towing away of any vehicles which violate this Declaration or the Rules and Regulations of the Association, with the costs to be borne by the Owner or violator. In addition, the Board of Directors may adopt Rules and Regulations

from time to time regulating and limiting the size, weight, type and place and manner of operation of vehicles on the Condominium Property.

- 15.17 Additional Rules and Regulations. The Association may promulgate such other Rules and Regulations as it determines to be in the best interests of the Unit Owners, and such additional Rules and Regulations shall, as long as they remain in force, be deemed additional covenants and restrictions as to the ownership, use, and occupation of the Condominium Property.
- 15.18 Relief by Association. The Association shall have the right (but not the obligation) to grant relief in particular circumstances from the provisions of the specific restrictions contained in this Section 15 for good cause shown.
- 15.19 Effects on Developer. The restrictions and limitations set forth in this Section 15 shall not apply to the Developer, its designees, successors and assigns, or to Units owned by or leased to the Developer, except for those specific restrictions and limitations contained herein that pertain to Association approval of leases, presence of pets, the occupancy of Units, and on the type of vehicles allowed to park on Condominium Property or Association Property; provided, however, the Developer and its designees shall have the right to be exempt from any such parking restriction if the vehicle is engaged in any activity relating to construction, maintenance, or marketing of Units.
16. Selling, Transferring and Mortgaging of Units. The following shall apply to all sales, transfer and mortgaging of Units:
- 16.1 Right of First Refusal. In the event a Unit Owner sells his or her Unit during the Repurchase Period, as hereinafter defined, Developer reserves the right to repurchase the Unit from the Unit Owner. The Repurchase Period shall mean a period of time to expire upon the earlier to occur of (i) a period of eighteen (18) months following the date of the Unit Owner's closing on the Unit, or (ii) for so long as the Developer continues to offer Units in the Condominium for sale in the ordinary course of business (the "Repurchase Period").
- 16.2 Sales. Upon expiration of the Right of First Refusal described herein, there shall be no restriction on the right of any Unit Owner to sell, convey, or transfer his Unit. However, every new Unit Owner must notify the Association of his purchase or acquisition of the Unit by providing the Association with a copy of the deed whereby the Unit Owner acquired title to his Unit within thirty (30) days of the transfer of ownership. Any deed or conveyance to a new Unit Owner shall automatically be deemed to provide that the acceptance thereof by the grantee shall constitute an assumption of the provisions of the Declaration, the By-Laws, the Articles of Incorporation, the Rules and Regulations, and all other agreements, documents or instruments affecting the Condominium Property, as the same may be amended from time to time.

- 16.3 No Severance of Ownership. Subject to the right to transfer parking spaces and storage spaces as described in Section 3.3 hereof, and subject to the other provisions of this Declaration, no part of the Common Elements may be sold, conveyed or otherwise disposed of, except as an appurtenance to the Unit in connection with a sale, conveyance or other disposition of the Unit to which such interest is appurtenant, and any sale, conveyance or other disposition of a Unit shall be deemed to include that Unit's appurtenant interest in the Common Elements.
- 16.4 Gifts and Devises, etc. Any Unit Owner shall be free to convey or transfer his Unit by gift, to devise his Unit by will, or to have his Unit pass by intestacy, without restriction; provided, however, that each succeeding Unit Owner shall be bound by, and his Unit subject to, the provisions of this Section 16.
- 16.5 Mortgage of Units. Each Unit Owner shall have the right to mortgage his Unit without restriction.
17. Compliance and Default. The Association, each Unit Owner, occupant or tenant of a Unit, and other invitees of a Unit Owner, shall be governed by and shall comply with the terms of this Declaration of Condominium and all exhibits annexed hereto, and the Rules and Regulations adopted pursuant to those documents, as the same may be amended from time to time, and the provisions of all such documents shall be deemed incorporated into any lease of a Unit whether or not expressly stated in such lease. The Association (and Unit Owners, if appropriate) shall be entitled to the following relief in addition to the remedies provided by the Act:
- 17.1 Negligence. A Unit Owner and/or tenant of a Unit shall be liable for the expense of any maintenance, repair or replacement made necessary by his or her negligence or by that of any member of his or her family or his or her or their guests, employees, agents or lessees, but only to the extent such expense is not met by the proceeds of insurance actually collected in respect of such negligence by the Association.
- 17.2 Compliance. In the event a Unit Owner, tenant or occupant fails to maintain a Unit or fails to cause such Unit to be maintained, or fails to observe and perform all of the provisions of the Declaration, the By-Laws, the Articles of Incorporation of the Association, the Rules and Regulations, or any other agreement, document or instrument affecting the Condominium Property in the manner required, the Association shall have the right to proceed in court to require performance and/or compliance, to impose any applicable fines, to sue in a court of law for damages, to make a special charge against the Unit Owner and the Unit for the sums necessary to do whatever work is required to put the Unit Owner or Unit in compliance, and to hire an attorney to make a charge against the Unit Owner and Unit for the costs of such reasonable attorneys' fees incurred in requiring performance and/or compliance of the Unit Owner. In addition, the Association has the irrevocable right of access to each Unit during reasonable hours, when necessary, for the maintenance, repair, or replacement of any Common Elements

or of any portion of a Unit to be maintained by the Association pursuant to the Declaration or as necessary to prevent damage to the Common Elements or to a Unit or Units.

- 17.3 Fines. In the event a Unit Owner, tenant, invitee, licensee, guest, contractor or occupant fails to observe and perform all of the provisions of the Declaration, the By-Laws, the Articles of Incorporation of the Association, Rules and Regulations, or any other agreement, document or instrument affecting the Condominium Property in the manner required, the Association shall have the right to impose a fine against the Unit Owner and the Unit. The amount of any fine shall be determined by the Board of Directors of the Association, but in any event shall not exceed any maximum amount permitted by the Act, as such Act may be amended from time to time. Any fine shall be imposed by written notice to the Unit Owner or tenant, signed by an officer of the Association, which shall state the amount of the fine, the violation for which the fine is imposed, and shall specifically state that the Unit Owner or tenant has the right to contest the fine by delivering written notice to the Association within fourteen (14) days after receipt of the notice imposing the fine. If the Unit Owner or tenant timely and properly objects to the fine, a committee of other Unit Owners ("Unit Owner Committee") appointed by the Board of Directors of the Association for the purpose of conducting these types of hearings shall conduct a hearing within thirty (30) days after receipt of the Unit Owner's or tenant's objection, and shall give the Unit Owner or tenant not less than fourteen (14) days written notice of the hearing date. Such notice shall include:

- (i) A statement of the date, time and place of the hearing;
- (ii) A statement of the provisions of the Declaration, Association By-Laws, or Association Rules and Regulations which have allegedly been violated; and
- (iii) A short and plain statement of the matters asserted by the Association.

At the hearing, the Unit Owner Committee shall conduct a reasonable inquiry to determine whether the alleged violation in fact occurred and that the fine imposed is appropriate. The Unit Owner or tenant shall have the right to attend the hearing and to respond to any material considered by the Association and to produce evidence on his behalf and to provide written and oral argument on all issues involved and shall have an opportunity at the hearing to review, challenge and respond to any material considered by the Association. If the Unit Owner or tenant fails to attend the hearing, then the hearing will be deemed waived and the Unit Owner Committee may ratify the fine without further proceedings. At the hearing, the Unit Owner Committee shall ratify the fine or if the Unit Owner Committee does not agree with the fine, it may reduce or eliminate the fine and shall give the Unit Owner or tenant written notice of its decision. Any fine shall be due and payable within fourteen (14) days after written notice of the

imposition of the fine, or if a hearing is timely requested within fourteen (14) days after written notice of the Unit Owner Committee's decision at the hearing. If any fine is levied against a tenant and is not paid within fourteen (14) days after same is due, the Association shall have the right to evict the tenant as hereinafter provided.

- 17.4 **Costs and Attorneys' Fees.** In any proceeding arising because of an alleged failure of a Unit Owner, tenant, occupant, invitee, licensee, guest, or contractor to comply with the requirements of the Act, this Declaration, the exhibits annexed hereto, or the Rules and Regulations adopted pursuant to said documents, as the same may be amended from time to time, the prevailing party shall be entitled to recover the costs of the proceeding and reasonable attorneys' fees (including appellate attorneys' fees).
- 17.5 **No Waiver of Rights.** The failure of the Association or any Unit Owner to enforce any covenant, restriction or other provision of the Act, this Declaration, the exhibits annexed hereto, or the Rules and Regulations adopted pursuant to said documents, as the same may be amended from time to time, shall not constitute a waiver of their right to do so thereafter.
18. **Termination of Condominium.** The Condominium shall continue until (i) terminated by casualty loss, condemnation or eminent domain, as more particularly provided in this Declaration, or (ii) such time as withdrawal of the Condominium Property from the provisions of the Act is authorized by a vote of Owners owning all of the applicable interests in the Common Elements and by all of the holders of recorded mortgage liens affecting the Condominium Parcels. In the event such withdrawal is authorized as aforesaid, the Condominium Property shall be subject to an action for partition by any Unit Owner, mortgagee or lienor as if owned in common in which event the net proceeds of sale shall be divided among all Unit Owners in proportion to their respective interests in the Common Elements; provided, however, that no payment shall be made to a Unit Owner until there has first been paid off out of his share of such net proceeds all mortgages and liens on his Unit in the order of their priority. The termination of the Condominium, as aforesaid, shall be evidenced by a certificate of the Association executed by its President and Secretary, certifying as to the basis of the termination and said certificate shall be recorded among the Public Records of the County. This Section may not be amended without the consent of the Primary Institutional First Mortgagee and the Developer as long as it owns at least one (1) Unit.
19. **Additional Rights of Mortgagees and Others.**
- 19.1 Institutional First Mortgagees shall have the right, upon written request to the Association, to: (i) examine the Condominium documents and the Association's books and records, (ii) receive a copy of the Association's audited financial statement for the immediately preceding fiscal year, which audited financial statement must be available within one hundred twenty (120) days of the Association's fiscal year end, (iii) receive notices of and attend Association meetings, (iv) receive notice of any alleged default in any obligations hereunder

by any Unit Owner, on whose Unit such Institutional First Mortgagee holds a mortgage, which is not cured within thirty (30) days of notice of default to the Unit Owner, and (v) receive notice of any substantial damage or loss to any portion of the Condominium Property.

- 19.2 Any holder, insurer or guarantor of a mortgage on a Unit shall have, if first requested in writing from the Association, the right to timely written notice of (i) any condemnation or casualty loss affecting a material portion of the Condominium Property or the affected mortgaged Unit, (ii) a sixty (60) day delinquency in the payment of the Assessments on a mortgaged Unit, (iii) the occurrence of a lapse, cancellation or material modification of any insurance policy or fidelity bond maintained by the Association, (iv) any proposed termination of the Condominium, and (v) any proposed action which requires the consent of a specified number of mortgage holders.
20. **Covenant Running With the Land.** All provisions of this Declaration, the Articles, the By-Laws and the Rules and Regulations of the Association shall, to the extent applicable and unless otherwise expressly herein or therein provided to the contrary, be perpetual and be construed to be covenants running with the Land and with every part thereof and interest therein, and all of the provisions hereof and thereof shall be binding upon and inure to the benefit of the Developer and subsequent owner(s) of the Land or any part thereof, or interest therein, and their respective heirs, personal representatives, successors and assigns, but the same are not intended to create nor shall they be construed as creating any rights in or for the benefit of the general public. All present and future Unit Owners, tenants and occupants of Units shall be subject to and shall comply with the provisions of this Declaration, the Articles, the By-Laws and Rules and Regulations as they may be amended from time to time. The acceptance of a deed of conveyance, or the entering into of a lease, or the entering into occupancy of any Unit, shall constitute an adoption and ratification of the provisions of this Declaration, and the Articles, the By-Laws and the Rules and Regulations of the Association as they may be amended from time to time, including, but not limited to, a ratification of any appointments of attorneys-in-fact contained herein.
21. **Disclaimer of Warranties.** Notwithstanding that this Condominium is a conversion of previously occupied premises, the Developer has elected to warrant the improvements solely to the extent provided in Section 718.618, Florida Statutes. Except only for those warranties provided in Section 718.618, Florida Statutes (and only to the extent applicable and not yet expired), to the maximum extent lawful, the Developer hereby disclaims any and all and each and every express or implied warranties, whether established by statutory, common, case law or otherwise, as to the design, construction, sound and/or odor transmission, existence and/or development of mold, mildew, toxins or fungi, furnishing and equipping of the Condominium Property, including, without limitation, any implied warranties of habitability, fitness for a particular purpose or merchantability, compliance with plans, all warranties imposed by statute (other than those imposed by Section 718.618, Florida Statutes, and then only to the extent applicable and not yet expired) and all other express and implied warranties of any kind or character. The Developer has not given and the Unit Owner has not relied on or

bargained for any such warranties. Each Unit Owner recognizes and agrees that the Unit and Condominium are not new construction. Each Unit Owner by accepting a deed to a Unit, shall be deemed to represent and warrant to the Developer that in deciding to purchase the Unit, the Unit Owner relied solely on the Unit Owner's independent inspection of the Unit and the Condominium as well as the conversion inspection reports included in the Prospectus. The Unit Owner has not received nor relied on any warranties and/or representations from the Developer of any kind, other than as expressly provided herein.

As to any implied warranty which cannot be disclaimed entirely, all secondary, incidental and consequential damages are specifically excluded and disclaimed (claims for such secondary, incidental and consequential damages being clearly unavailable in the case of implied warranties which are disclaimed entirely above).

Further, given the climate and humid conditions in Florida, mold, mildew, toxins and fungus may exist and/or develop within the Unit and/or Condominium Property. Each Unit Owner is hereby advised that certain mold may be, or if allowed to remain for a sufficient period may become, toxic and potentially pose a health risk. By accepting a deed to a Unit, each Unit Owner shall be deemed to have assumed the risks associated with mold, mildew, toxins and/or fungi and to have released the Developer and the fee simple owner of the Condominium Property (if other than the Developer) from any and all liability resulting from same.

In addition, each Owner, by acceptance of a deed to a Unit, agrees and acknowledges that there are different means and methods of calculating the square footage of a particular Unit and that depending on the method, the quoted square footage of the Unit may vary by more than a nominal amount if the Owner applies a method other than the survey method of calculating square footage. Additionally, as a result of in-the-field construction and other permitted changes, together with the settling and shifting of Improvements, actual square footage may also be affected. By accepting title to such Unit, each Owner shall be deemed to have conclusively agreed to accept the size and dimensions of the Unit regardless of any variances in the square footage from that which may have been disclosed at any time prior to closing, whether included as part of the Developer's promotional materials or otherwise. Without limiting the generality of this section 21, the Developer does not make any representation or warranty as to the actual size, dimensions or square footage of any Unit, and each Owner shall be deemed to have fully waived and released any such warranty and claims for loss or damage resulting from any variances between any represented or otherwise disclosed square footage and the actual square footage of the Unit.

22. **Lake Meadowbrook Association Provisions.**

- 22.1 **Maintenance and Upkeep of System.** Subject to, and in accordance with the provisions of the Lake Meadowbrook Declaration, the Lake Meadowbrook Association shall be responsible for the maintenance, operation, repair and upkeep of Lake No. 8 and the System as well as maintenance of the Lake as an aesthetically attractive feature, free of algae and nuisance water plants and free-

flowing. "Maintenance of the System" shall mean the exercise of practices which allow the System to provide drainage, water storage, conveyance or other surface water or stormwater management capabilities as permitted by the St. Johns River Water Management District Permit Number 4-031-0510A.

- 22.2 Ownership and Costs and Expenses of System. The Condominium Association shall pay annually to the Lake Meadowbrook Association its pro-rata share of the total cost of maintaining and operating the System. Each Unit Owner shall pay as part of its Assessments a pro-rata share of the Condominium Association's obligations under the Lake Meadowbrook Declaration. The total cost of maintaining and operating the System shall be comprised of those costs for administration, operation, maintenance, alteration, repair and tax liability for the System as determined by the Lake Meadowbrook Association.
- 22.3 Membership in the Lake Meadowbrook Association. Pursuant to the Articles of Incorporation of the Lake Meadowbrook Association, the Condominium Association shall be deemed a member of the Lake Meadowbrook Association and the owner of that Building Site (as defined in the Lake Meadowbrook Declaration) for purposes of the Articles and the By-Laws of the Lake Meadowbrook Association. Furthermore, the Condominium Association shall be entitled to send only one (1) representative to any meeting of the members of the Lake Meadowbrook Association. The Condominium Association shall be entitled to that number of votes which is equal to the total number of acres (rounded to the near 1/100th of an acre) of the Condominium Property. The votes cast by the Condominium Association shall be exercised as determined by all unit owners eligible to vote in accordance with the Declaration, Articles and By-Laws of the Condominium, but in no event shall more than one (1) ballot be cast on behalf of the Condominium Association. If the unit owners cast more than one (1) ballot, all of the same shall be disregarded.
- 22.4 Non-Performance; Lien Rights. PURSUANT TO SECTION 7 OF THE LAKE MEADOWBROOK DECLARATION, THERE IS A LIEN OR LIEN RIGHT AGAINST EACH UNIT TO SECURE THE PAYMENT OF ASSESSMENTS OR OTHER EXACTIONS COMING DUE FOR THE CONSTRUCTION, OPERATION, MAINTENANCE, ALTERATION, REPAIR, OWNERSHIP, USE AND UPKEEP OF THE SURFACE WATER AND STORM WATER MANAGEMENT SYSTEM WHICH ASSESSMENTS SHALL BE MADE PAYABLE TO THE LAKE MEADOWBROOK LAKE OWNERS' ASSOCIATION, INC. THE UNIT OWNER'S FAILURE TO MAKE THESE PAYMENTS MAY RESULT IN FORECLOSURE OF THE LIEN.
- 22.5 Use of System Property. Each Unit Owner may use the Lake for small pram boats, paddle boats, and similar small, recreational boats. Electric trolling motors may be used, but gasoline, diesel or other powered motors are prohibited (except on boats used by the Lake Meadowbrook Association or its agents in maintaining the Lake).

THE PROPERTY HAS BEEN OR WILL BE DEVELOPED IN ACCORDANCE WITH THE REQUIREMENTS OF A PERMIT ISSUED BY THE ST. JOHNS RIVER WATER MANAGEMENT DISTRICT ("DISTRICT") UNDER PERMIT NUMBER 4-031-0510A ("PERMIT"). THE ASSOCIATION HAS THE OBLIGATION TO ASSURE THAT ALL TERMS AND CONDITIONS THEREOF ARE ENFORCED. THE DISTRICT, THE LAKE MEADOWBROOK ASSOCIATION AND/OR THE LAKE NUMBER ONE ASSOCIATION SHALL HAVE THE RIGHT TO BRING AN ACTION, AT LAW OR IN EQUITY, AGAINST ANY OWNER OR ASSOCIATION VIOLATING ANY PROVISION OF THE PERMIT.

FURTHER, ANY UNIT OWNER OR OWNER OF A BUILDING SITE (AS DEFINED IN THE DECLARATION OF COVENANTS AND RESTRICTIONS FOR OPERATION AND MAINTENANCE OF SURFACE WATER OR STORMWATER MANAGEMENT SYSTEM) WHICH CONTAINS OR IS ADJACENT TO JURISDICTIONAL WETLANDS OR CONSERVATION AREAS AS ESTABLISHED BY THE DISTRICT OR BY ANY APPLICABLE CONSERVATION EASEMENT SHALL BY ACCEPTANCE OF TITLE TO THE UNIT OR BUILDING SITE, BE DEEMED TO HAVE ASSUMED THE OBLIGATION TO COMPLY WITH THE REQUIREMENTS OF THE PERMIT AS THE SAME RELATE TO SUCH OWNER'S UNIT OR BUILDING SITE AND SHALL AGREE TO MAINTAIN SUCH JURISDICTIONAL WETLANDS AND CONSERVATION AREAS IN THE CONDITION REQUIRED UNDER THE PERMIT. IN THE EVENT THAT THE ASSOCIATION OR UNIT OWNER VIOLATES THE TERMS AND CONDITIONS OF THE PERMIT AND FOR ANY REASON LAKE MEADOWBROOK ASSOCIATION OR LAKE NUMBER ONE ASSOCIATION IS CITED THEREFORE, THE UNIT OWNER AND/OR ASSOCIATION AGREE TO INDEMNIFY AND HOLD THE LAKE MEADOWBROOK ASSOCIATION AND LAKE NUMBER ONE ASSOCIATION HARMLESS FROM ALL COSTS ARISING IN CONNECTION THEREWITH, INCLUDING WITHOUT LIMITATION ALL COURT COSTS AND ATTORNEYS' FEES, AS WELL AS ALL COSTS OF CURING SUCH VIOLATION. NO PERSON SHALL ALTER THE DRAINAGE FLOW OF THE STORMWATER MANAGEMENT SYSTEM OR ANY PORTION OF THE JURISDICTIONAL WETLANDS OR CONSERVATION AREAS, INCLUDING WITHOUT LIMITATION, ANY BUFFER AREAS, SWALES, TREATMENT BERMS OR SWALES, WITHOUT THE PRIOR WRITTEN APPROVAL OF THE DISTRICT, AS APPLICABLE.

23. **Lake Number One Easement Agreement.**

- 23.1 **Maintenance of Easement Property, Costs.** Subject to, and in accordance with the provisions of the Lake Number One Easement Agreement, the Condominium Association shall pay its pro-rata share of the costs of maintenance, repair, operation, reconstruction, upkeep and capital improvements needed to keep Lake No. 1 in good working order and in compliance with all applicable permits. Each Unit Owner shall pay as part of its Assessments a pro-rata share of the Condominium Association's obligations under the Lake Number One Easement Agreement.
- 23.2 **Membership in the Lake Number One Association.** Pursuant to the Articles of Incorporation of the Lake Number One Association, the Condominium Association shall be deemed a member of the Lake Number One Association and

the owner of that Building Site for purposes of the Articles and the By-Laws of the Lake Number One Association. Furthermore, the Condominium Association shall be entitled to send only one (1) representative to any meeting of the members of the Lake Number One Association. The Condominium Association shall be entitled to that number of votes which is equal to the total number of acres (rounded to the near 1/100th of an acre) of the Condominium Property. The votes cast by the Condominium Association shall be exercised as determined by all unit owners eligible to vote in accordance with the Declaration, Articles and By-Laws of the Condominium, but in no event shall more than one (1) ballot be cast on behalf of the Condominium Association. If the unit owners cast more than one (1) ballot, all of the same shall be disregarded.

- 23.3 Failure to Pay Pro-Rata Shares, Lien. PURSUANT TO SECTION 4 OF THE LAKE NUMBER ONE EASEMENT AGREEMENT, THERE IS A LIEN OR LIEN RIGHT AGAINST EACH UNIT TO SECURE THE PAYMENT OF ASSESSMENTS OR OTHER EXACTIONS COMING DUE FOR THE COSTS OF MAINTENANCE, REPAIR, OPERATION, RECONSTRUCTION, UPKEEP AND CAPITAL IMPROVEMENTS NEEDED TO KEEP LAKE NO. 1 IN GOOD WORKING ORDER AND IN COMPLIANCE WITH ALL APPLICABLE PERMITS WHICH ASSESSMENTS SHALL BE MADE PAYABLE TO LAKE NUMBER ONE OWNERS' ASSOCIATION, INC. THE UNIT OWNER'S FAILURE TO MAKE THESE PAYMENTS MAY RESULT IN FORECLOSURE OF THE LIEN.

24. Additional Provisions.

- 24.1 Notices. All notices to the Association required or desired hereunder or under the By-Laws of the Association shall be sent by certified mail (postage pre-paid return receipt requested) to the Association in care of its office at the Condominium, or to such other address as the Association may hereafter designate from time to time by notice in writing to all Unit Owners. Except as provided specifically in the Act, all notices to any Unit Owner shall be sent by first class mail to the Condominium address of such Unit Owner, or such other address as may have been designated by the Unit Owner from time to time, in writing, to the Association. All notices to mortgagees of Units shall be sent by first class mail to their respective addresses, or such other address as may be designated by them from time to time, in writing to the Association. All notices shall be deemed to have been given when mailed in a postage prepaid sealed wrapper, except notices of a change of address, which shall be deemed to have been given when received, or 5 business days after proper mailing, whichever shall first occur.
- 24.2 Interpretation. The Board of Directors of the Association shall be responsible for interpreting the provisions hereof and any of the Exhibits attached hereto. Such interpretation shall be binding upon all parties unless wholly unreasonable. An opinion of legal counsel that any interpretation adopted by the Association is not unreasonable shall conclusively establish the validity of such interpretation.

- 24.3 Mortgagees. Anything herein to the contrary notwithstanding, the Association shall not be responsible to any mortgagee or lienor of any Unit hereunder, and may assume the Unit is free of any such mortgages or liens, unless written notice of the existence of such mortgage or lien is received by the Association.
- 24.4 Exhibits. All Exhibits to this Declaration and all materials contained therein are hereby incorporated in this Declaration.
- 24.5 Signature of President and Secretary. Wherever the signature of the President of the Association is required hereunder, the signature of a vice-president may be substituted therefor, and wherever the signature of the Secretary of the Association is required hereunder, the signature of an assistant secretary may be substituted therefor, provided that the same person may not execute any single instrument on behalf of the Association in two separate capacities.
- 24.6 Governing Law. Should any dispute or litigation arise between any of the parties whose rights or duties are affected or determined by this Declaration, the Exhibits annexed hereto or the applicable Rules and Regulations adopted pursuant to such documents, as the same may be amended from time to time, said dispute or litigation shall be governed by the laws of the State of Florida.
- 24.7 Severability. The invalidity in whole or in part of any covenant or restriction, or any Section, subsection, sentence, clause, phrase or word, or other provision of this Declaration, the Exhibits annexed hereto, or the Rules and Regulations adopted pursuant to such documents, as the same may be amended from time to time, shall not affect the validity of the remaining portions thereof which shall remain in full force and effect.
- 24.8 Waiver. No provisions contained in this Declaration, the Exhibits annexed hereto or the Rules and Regulations adopted pursuant to such documents, as the same may be amended from time to time, shall be deemed to have been waived by reason of any failure to enforce the same, without regard to the number of violations or breaches which may occur.
- 24.9 Ratification. Each Unit Owner, by reason of having acquired ownership (whether by purchase, gift, operation of law or otherwise), and each tenant and occupant of a Unit, by reason of his or her occupancy, shall be deemed to have acknowledged and agreed that all of the provisions of this Declaration, and the Articles and By-Laws of the Association, and applicable Rules and Regulations, are fair and reasonable in all material respects.
- 24.10 Execution of Documents; Attorney-in-Fact. Without limiting the generality of other Sections of this Declaration and without such other Sections limiting the generality hereof, each Owner, by reason of the acceptance of a deed to such Owner's Unit, hereby agrees to execute, at the request of the Developer, all documents or consents which may be required by all governmental agencies to allow the Developer and its affiliates to complete the plan of development of the

Land as such plan may be hereafter amended, and each such Owner further appoints hereby and thereby the Developer as such Owner's agent and attorney-in-fact to execute, on behalf and in the name of such Owners, any and all of such documents or consents. This power of attorney is irrevocable and coupled with an interest. The provisions of this subsection may not be amended without the prior written consent of the Developer.

- 24.11 Gender; Plurality. Wherever the context so permits, the singular shall include the plural, the plural shall include the singular, and the use of any gender shall be deemed to include all or no genders.
- 24.12 Captions. The captions herein and in the Exhibits annexed hereto are inserted only as a matter of convenience and for ease of reference and in no way define or limit the scope of the particular document or any provision thereof.
- 24.13 Access of Developer to Building and Units. For as long as the Developer remains liable to the Condominium Association under any warranty, whether statutory, express or implied, for any act or omission of the Developer in the development, construction, sale and marketing of the Condominium, then the Developer and its designees and agents shall have the right, in the Developer's sole discretion, and from time to time, to enter the Condominium Property for the purpose of inspecting, testing and surveying same, to determine the need for repairs, improvements or replacements, so as to permit the Developer to fulfill its obligations under such warranties. Failure of the Condominium Association or of a Unit Owner to grant such access may result in the appropriate warranty being nullified and of no further force or effect.
- 24.14 Mandatory Non-Binding Arbitration of Disputes.
- (a) Prior to the institution of court litigation, the parties to a dispute, as further defined herein, shall petition the Division for non-binding arbitration. Arbitration shall be conducted according to rules promulgated by the Division. The filing of a petition for arbitration shall toll the applicable statute of limitations. For purposes of this subsection 22.14, a "dispute" shall be as defined pursuant to Section 718.1255, Florida Statutes, as amended from time to time.
- (b) At the request of any party to the arbitration, such arbitrator shall issue subpoenas for the attendance of witnesses and the production of books, records, documents, and other evidence and any party on whose behalf a subpoena is issued may apply to the court for orders compelling such attendance and production. Subpoenas shall be served and shall be enforceable in the manner provided by the Florida Rules of Civil Procedure. Discovery may in the discretion of the arbitrator be permitted in the manner provided by the Florida Rules of Civil Procedure.

- (c) The arbitration decision shall be presented to the parties in writing. An arbitration decision shall be final if a complaint for a trial *de novo* is not filed within 30 days in a court of competent jurisdiction in which the Condominium is located following the date of issuance of the arbitration decision. The right to file for a trial *de novo* entitles the parties to file a complaint in the appropriate trial court for a judicial resolution of the dispute. The prevailing party in an arbitration proceeding may be awarded reasonable attorneys' fees, the costs of the arbitration, or both, in an amount determined in the discretion of the arbitrator.
- (d) The party who files a complaint for a trial *de novo* shall be assessed the other party's arbitration costs, court costs, and other reasonable costs, including attorneys' fees, investigation expenses, and expenses for expert or other testimony or evidence incurred after the arbitration hearing if the judgment upon the trial *de novo* is not more favorable than the arbitration decision. If the judgment is more favorable, the party who filed a complaint for trial *de novo* shall be awarded reasonable court costs and attorneys' fees.
- (e) The decision of an arbitrator shall be final; however, such a decision shall not be deemed final agency action. Nothing in this provision shall be construed to foreclose parties from proceeding in a trial *de novo*. If such judicial proceedings are initiated, the final decision of the arbitrator shall be admissible in evidence in the trial *de novo*.
- (f) Any party to an arbitration proceeding may enforce an arbitration award by filing a petition in a court of competent jurisdiction in which the Condominium is located. A petition may not be granted unless the time for appeal by filing of a complaint for trial *de novo* has expired. If a complaint for a trial *de novo* has been filed, a petition may not be granted with respect to an arbitration award that has been stayed. If the petition is granted, the petitioner may recover reasonable attorneys' fees and costs incurred in enforcing the arbitration award.

24.15 Priorities in Case of Conflict. In the event of conflict between or among the provisions of any of the following, the order of priority shall be, from highest priority to lowest:

- (a) The Act, as it existed on the date of recording of the Declaration;
- (b) The Declaration;
- (c) The Articles;
- (d) The By-Laws; and
- (e) The Rules and Regulations of the Association.

IN WITNESS WHEREOF, the Developer has caused this Declaration to be executed by its duly authorized officer this 1st day of November, 2005.

WITNESSES:

Omni-Tivoli, LLC, a Florida limited liability company

D. Ruggino
Name: D. Ruggiero

By: Tarragon South Development Corp., a Nevada corporation, its sole member and manager

Kathleen S. Markell
Name: Kathleen S. Markell

By: Marcy H. Kammerman
Name: _____

Title: Marcy H. Kammerman
Executive Vice President

STATE OF FLORIDA
COUNTY OF Broward

The foregoing instrument was acknowledged before me this 1st day of November, 2005, by Marcy H. Kammerman as the Executive Vice President of Tarragon South Development Corp., a Nevada corporation as the sole member and manager of Omni-Tivoli, LLC, a Florida limited liability company. ~~He~~ She is () personally known to me or () has produced his/her Florida driver's license as identification.

Kathleen S. Markell
Notary Public
Name: Kathleen S. Markell
Commission Expires : _____

(Notary Seal)



Kathleen S. Markell
My Commission DD178078
Expires March 09, 2007

JOINDER BY MORTGAGEE

The undersigned Mortgagee does hereby join in and consent to the foregoing Declaration of Condominium and agrees that the lien of its Mortgage, Security Agreement and Fixture Filing, dated July 6, 2005 and recorded in Official Records Book 12604, at Page 2090, and the Assignment of Rents and Leases dated July 6, 2005 and recorded in Official Records Book 12604, Page 2103, all of the Public Records of Duval, County, Florida, and any other security or financing agreements held by said Mortgagee on the said property, are hereby subject, subordinate and inferior to said Declaration.

Mortgagee makes no warranty or any representation of any kind or nature concerning the Declaration, any of its terms or provisions, or the legal sufficiency thereof, and disavows any such warranty or representation as well as any participation in the development of Mirabella, a Condominium ("Condominium") and does not assume and shall not be responsible for any of the obligations or liabilities contained in the Declaration or other documents used in connection with the promotion of the Condominium. None of the representations contained in the Declaration or other documents shall be deemed to have been made by Mortgagee, nor shall they be construed to create any obligations on Mortgagee to any person relying thereon. Nothing contained herein shall affect or impair the rights and remedies of Mortgagee as set forth in any of its security instruments in connection with the Land or in the Declaration.

The undersigned has caused this Joinder to be executed by its duly authorized officer this ____ day of _____, 2005.

WITNESSES:

GENERAL ELECTRIC CAPITAL CORPORATION, a Delaware corporation

Print Name: _____

By: _____
Name: _____
Its: _____

Print Name: _____

Post Office Address:
301 Yamato Road
Boca Raton, Florida 33431

STATE OF _____
COUNTY OF _____

I HEREBY CERTIFY that on the ____ day of _____, 2005, before me, an officer duly authorized to take acknowledgements, personally appeared _____, as _____ of General Electric Capital Corporation, a Delaware corporation, for and on behalf of the entity, who is personally known to me or has produced his Florida driver's license as identification.

Name: _____
Notary Public

(Notary Seal)

EXHIBITS
TO
DECLARATION OF CONDOMINIUM
OF
MIRABELLA, A CONDOMINIUM

EXHIBIT "1" - LEGAL DESCRIPTION OF REAL PROPERTY BEING SUBMITTED TO CONDOMINIUM OWNERSHIP

EXHIBIT "2" - ARTICLES OF INCORPORATION OF MIRABELLA I CONDOMINIUM ASSOCIATION, INC.

EXHIBIT "3"- BY-LAWS OF MIRABELLA I CONDOMINIUM ASSOCIATION, INC.

EXHIBIT "4" - PLOT PLAN, SURVEY AND GRAPHIC DESCRIPTION OF IMPROVEMENTS

EXHIBIT "5" - PERCENTAGE OWNERSHIP AND SHARES IN COMMON ELEMENTS

EXHIBIT "1"

LEGAL DESCRIPTION OF REAL PROPERTY BEING SUBMITTED
TO CONDOMINIUM OWNERSHIP

Exhibit "A"

(FEE PARCEL)

A portion of Section 7, Township 3 South, Range 28 East, Jacksonville, Duval County, Florida, being more particularly described as follows:

For a Point of Reference, commence at the intersection of the West line of said Section 7, with the Northerly right of way line of Gate Parkway North (a 120 foot right of way as now established, by Plat Book 47, Pages 59 through 59I of the current Public Records of said county); run thence South $80^{\circ} 22' 08''$ East, along said Northerly right of way line, a distance of 571.88 feet to a point on a curve, also being the Point of Beginning.

From the Point of Beginning thus described, run thence Northwesterly along the arc of a curve concave Northeasterly with a radius of 50.00 feet, an arc distance of 96.00 feet to the point of tangency of said curve, said arc being subtended by a chord bearing and distance of North $25^{\circ} 21' 51''$ West, 81.92 feet; run thence North $29^{\circ} 38' 27''$ East, a distance of 596.13 feet; run thence North $60^{\circ} 12' 34''$ East, a distance of 1603.79 feet; run thence South $28^{\circ} 04' 24''$ East, a distance of 361.64 feet to a point of curvature; run thence Southeasterly along the arc of a curve concave Northeasterly with a radius of 100.00 feet, an arc distance of 162.73 feet to a point on said curve, said arc being subtended by a chord bearing and distance of South $74^{\circ} 41' 26''$ East, 145.36 feet; run thence South $27^{\circ} 14' 16''$ East, a distance of 106.10 feet to the Northerly line of those lands described in Official Records Volume 8207, page 760; run thence Southwesterly along said Northerly line as follows: First course, run thence South $39^{\circ} 04' 48''$ West, a distance of 198.14 feet; Second course, run thence South $71^{\circ} 21' 25''$ West, a distance of 104.48 feet; Third course, run thence South $60^{\circ} 40' 47''$ West, a distance of 108.53 feet; Fourth course, run thence South $60^{\circ} 14' 12''$ West, a distance of 429.97 feet; Fifth course, run thence South $85^{\circ} 41' 32''$ West, a distance of 88.59 feet; Sixth course, run thence South $73^{\circ} 30' 14''$ West, a distance of 215.76 feet; Seventh course, South $62^{\circ} 37' 53''$ West, a distance 113.62 feet; Eighth course, South $53^{\circ} 14' 43''$ West, a distance of 60.07 feet; Ninth course, run thence South $55^{\circ} 44' 36''$ West, a distance of 155.23 feet; Tenth course, North $86^{\circ} 01' 31''$ West, a distance of 50.34 feet; Eleventh course, run thence South $52^{\circ} 48' 03''$ West, a distance of 200.26 feet; Twelfth course, South $46^{\circ} 07' 57''$ West a distance of 71.13 feet Thirteenth course, South $12^{\circ} 48' 27''$ West, a distance of 193.92 feet to a point on a curve, said point also lying on said Northerly right of line of Gate Parkway North; run thence Northwesterly along said Northerly right of way line, departing said Northerly line, as follows: First course, along the arc of a curve concave Southwesterly with a radius of 1492.40 feet, an arc distance of 339.82 feet to the point of tangency of said curve, said arc being subtended by a chord bearing and distance of North $73^{\circ} 50' 45''$ West, 339.08 feet; Second course, run thence North $80^{\circ} 22' 08''$ West, a distance of 116.63 feet to the Point of Beginning.

TOGETHER WITH:

- a. DRAINAGE EASEMENT AGREEMENT described in Official Records Book 9892, Page 1905 and drainage easements reserved in Paragraph 2 of Exhibit C of the Special Warranty Deed recorded in Official Records Book 8196, Page 942, all as assigned in Special Warranty Deed recorded in Official Records Book 9892, Page 1946, all the Public Records of Duval County, Florida.
- b. EASEMENT RIGHTS created by Declaration recorded in Official Records Book 8207, Page 785 as amended by instrument recorded in Official Records Book 9760, Page 851, both the Public Records of Duval County, Florida.
- c. GRANT OF EASEMENT recorded in Official Records Book 9995, Page 1835, as partially terminated by dedication to the JEA as set forth on the Plat of Old Mill Branch Unit One, as recorded in Plat Book 54, Pages 29, 29A, and 29B, all of the Public Records of Duval County, Florida.

EXHIBIT "2"

ARTICLES OF INCORPORATION OF MIRABELLA I
CONDOMINIUM ASSOCIATION, INC.

State of Florida



Department of State

I certify the attached is a true and correct copy of the Articles of Incorporation of MIRABELLA I CONDOMINIUM ASSOCIATION, INC., a Florida corporation, filed on September 6, 2005, as shown by the records of this office.

I further certify the document was electronically received under FAX audit number H05000212255. This certificate is issued in accordance with section 15.16, Florida Statutes, and authenticated by the code noted below.

The document number of this corporation is N05000009143.

Authentication Code: 805A00055570-090705-N05000009143-1/1

Given under my hand and the
Great Seal of the State of Florida,
at Tallahassee, the Capital, this the
Seventh day of September, 2005



Glenda E. Hood

Glenda E. Hood
Secretary of State

**ARTICLES OF INCORPORATION
FOR
MIRABELLA I CONDOMINIUM ASSOCIATION, INC.**

The undersigned incorporator, for the purpose of forming a **corporation not for profit** under the laws of the State of Florida, hereby adopts the following articles of incorporation:

ARTICLE 1

NAME

The name of the corporation is **MIRABELLA I CONDOMINIUM ASSOCIATION, INC.** For convenience, the corporation shall be referred to in this instrument as the "Association," these Articles of Incorporation as the "Articles," and the By-Laws of the Association as the "By-Laws."

ARTICLE 2

OFFICE

The principal office and mailing address of the Association shall be at 7001 Lake Ellenor Drive, Suite 200, Orlando, Florida 32809, or at such other place as may be subsequently designated by the Board of Directors. All books and records of the Association shall be kept at its principal office or at such other place as may be permitted by the Act.

ARTICLE 3

PURPOSE

This Association is organized for the purpose of providing an entity under the Florida Condominium Act, as it exists on the date hereof (the "Act"), for the operation of that certain condominium located in Duval County, Florida, and known as **MIRABELLA, A CONDOMINIUM** (the "Condominium Property" or "Condominium").

ARTICLE 4

DEFINITIONS

The terms used in these Articles shall have the same definitions and meaning as those set forth in the Declaration of Condominium ("Declaration"), to be recorded in the Public Records of Duval County, Florida, unless herein provided to the contrary, or unless the context otherwise requires.

Leigh Ann Murvin, P.L.
Broad and Cassel
390 N. Orange Ave., Suite 1100
Orlando, Florida 32801

All

ARTICLE 5

POWERS

The powers of the Association shall include and be governed by the following:

- 5.1 **General.** The Association shall have all of the common-law and statutory powers of a corporation not for profit under the laws of Florida that are not in conflict with the provisions of these Articles, the Declaration, the By-Laws or the Act.
- 5.2 **Enumeration.** The Association shall have all of the powers and duties set forth in the Act, and except as limited by the Act, those powers and duties set forth in these Articles, the By-Laws and the Declaration and all of the powers and duties reasonably necessary to operate the Condominium pursuant to the Declaration and as more particularly described in the By-Laws, as they may be amended from time to time, including, but not limited to, the following:
- (a) To make and collect Assessments and other charges against members as Unit Owners, and to use the proceeds thereof in the exercise of its powers and duties.
 - (b) To buy, accept, own, operate, lease, sell, trade and mortgage both real and personal property.
 - (c) To maintain, repair, replace, reconstruct, add to and operate the Condominium Property and Association Property, and other property acquired or leased by the Association.
 - (d) To purchase insurance upon the Condominium Property and Association Property and insurance for the protection of the Association, its officers, directors and Unit Owners.
 - (e) To make and amend reasonable rules and regulations for the maintenance, conservation and use of the Units and the Condominium Property and Association Property, and for the health, comfort, safety and welfare of the Unit Owners.
 - (f) To enforce by legal means the provisions of the Act, the Declaration, these Articles, the By-Laws, and the rules and regulations for the use of the Condominium Property and Association Property.
 - (g) To contract for the management and maintenance of the Condominium Property and Association Property and to authorize a management agent (which may be an affiliate of the Developer) to assist the Association in carrying out its powers and duties by performing such functions as the submission of proposals, collection of Assessments, preparation of records, enforcement of rules and maintenance, repair and replacement of the Common Elements and Association Property with such funds as shall be made available by the Association for such purposes. The Association and its officers shall, however, retain at all times the powers and duties granted by the Condominium Act, including, but not limited to, the making

of Assessments, promulgation of rules and execution of contracts on behalf of the Association.

- (h) To employ personnel to perform the services required for the proper operation of the Condominium Property and Association Property.
- 5.3 Association Property. All funds and the title to all properties acquired by the Association and their proceeds shall be held for the benefit and use of the members in accordance with the provisions of the Declaration, these Articles and the By-Laws.
- 5.4 Distribution of Income; Dissolution. The Association shall make no distribution of income to its members, directors, or officers, and upon dissolution, all assets of the Association shall be transferred only to another non-profit corporation or a public agency or as otherwise authorized by the Florida Not For Profit Corporation Act (Chapter 617, Florida Statutes).
- 5.5 Limitation. The powers of the Association shall be subject to and shall be exercised in accordance with the provisions hereof and of the Declaration, the By-Laws, and the Act, provided that in the event of conflict, the provisions of the Act shall control over those of the Declaration and By-Laws.

ARTICLE 6

MEMBERS

- 6.1 Membership. The members of the Association shall consist of all of the record title owners of Units in the Condominium from time to time, and after termination of the Condominium, shall consist of those who were members at the time of such termination and their successors and assigns.
- 6.2 Assignment. The share of a member in the funds and assets of the Association cannot be assigned, hypothecated or transferred in any manner except as an appurtenance to the Unit for which that share is held.
- 6.3 Voting. On all members upon which the membership shall be entitled to vote, there shall be only one vote for each Unit, which vote shall be exercised or cast in the manner provided by the Declaration and By-Laws. Any person or entity owning more than one Unit shall be entitled to one vote for each Unit owned unless otherwise provided in the Declaration.
- 6.4 Meetings. The By-Laws shall provide for an annual meeting of members, and may make provisions for regular and special meetings of members other than the annual meeting.

ARTICLE 7

TERM OF EXISTENCE

The Association shall have perpetual existence.

ARTICLE 8**INCORPORATOR**

The name and address of the Incorporator of this Corporation is:

<u>NAME</u>	<u>ADDRESS</u>
Leigh Ann Murvin	Leigh Ann Murvin, P.L. Broad and Cassel 390 N. Orange Ave., Suite 1100 Orlando, Florida 32801

ARTICLE 9**OFFICERS**

The affairs of the Association shall be administered by the officers holding the offices designated in the By-Laws. The officers shall be elected by the Board of Directors of the Association at its first meeting following the annual meeting of the members of the Association and shall serve at the pleasure of the Board of Directors. The By-Laws may provide for the removal from office of officers, for filling vacancies and for the duties and qualifications of the officers. The names and addresses of the officers who shall serve until their successors are designated by the Board of Directors are as follows:

President:	Anthony C. Martin 7001 Lake Ellenor Drive Suite 200 Orlando, Florida 32809
Vice President:	Sean Flanagan 7001 Lake Ellenor Drive Suite 200 Orlando, Florida 32809
Secretary:	Sean Flanagan 7001 Lake Ellenor Drive Suite 200 Orlando, Florida 32809
Treasurer:	Sean Flanagan 7001 Lake Ellenor Drive Suite 200 Orlando, Florida 32809

ARTICLE 10

DIRECTORS

10.1 Number and Qualification. The property, business and affairs of the Association shall be managed by a board consisting of the number of directors determined in the manner provided by the By-Laws, but which shall consist of not less than three (3) directors. During Developer control, Directors need not be members of the Association; however, upon turnover, Directors shall be members of the Association. When Unit Owners other than Omni-Tivoli, LLC, a Florida limited liability company, its successors or assigns (the "Developer") own fifteen percent (15%) or more of the Units that will be operated ultimately by the Association, such Unit Owners, other than the Developer, shall be entitled to elect no less than one-third (1/3) of the members of the Board of Directors.

Such Unit Owners, other than the Developer, are entitled to elect not less than a majority of the members of the Board:

- (a) Three (3) years after fifty percent (50%) of the Units that will be operated ultimately by the Association have been conveyed to purchasers;
- (b) Three (3) months after ninety percent (90%) of the Units that will be operated ultimately by the Association have been conveyed to purchasers;
- (c) When all of the Units that will be operated ultimately by the Association have been completed, some of them have been conveyed to purchasers, and none of the others are being offered for sale by the Developer in the ordinary course of business;
- (d) When some of the Units have been conveyed to purchasers and none of the others are being constructed or offered for sale by the Developer in the ordinary course of business; or
- (e) Seven (7) years after recordation of the Declaration.

Developer shall have the right to elect a majority of the Board until the first occurrence of any of the above events. Developer is entitled to elect at least one (1) Director as long as Developer holds for sale in the ordinary course of business at least five percent (5%) of the Units in the Condominium. Following the time the Developer relinquishes control of the Association, the Developer may exercise the right to vote any Developer owned Units in the same manner as any other Unit Owner except for purposes of reacquiring control of the Association or selecting the majority members of the Board. The right reserved herein to Developer to elect and maintain Directors may be assigned to and exercised by its successor(s) in interest.

10.2 Duties and Powers. All of the duties and powers of the Association existing under the Act, the Declaration, these Articles and the By-Laws shall be exercised exclusively by

the Board of Directors, its agents, contractors or employees, subject only to approval by Unit Owners when such approval is specifically required.

- 10.3 Election; Removal. Directors of the Association shall be elected at the annual meeting of the members in the manner determined by and subject to the qualifications set forth in the By-Laws. Directors may be removed and vacancies on the Board of Directors shall be filled in the manner provided by the By-Laws.
- 10.4 Term of Developer's Directors. The Developer of the Condominium shall appoint the members of the first Board of Directors and their replacements who shall hold office for the periods described in the By-Laws.
- 10.5 First Directors. The names and addresses of the members of the first Board of Directors who shall hold office until their successors are elected and have taken office, as provided in the By-Laws, are as follows:

<u>NAME</u>	<u>ADDRESS</u>
Anthony C. Martin	7001 Lake Ellenor Drive Suite 200 Orlando, Florida 32809
Sean Flanagan	7001 Lake Ellenor Drive Suite 200 Orlando, Florida 32809
Marcy H. Kammerman	200 East Las Olas Boulevard Suite 1660 Fort Lauderdale, Florida 33301

ARTICLE 11

INDEMNIFICATION

- 11.1 Indemnity. The Association shall indemnify any person who was or is a party or is threatened to be made a party to any threatened, pending or contemplated action, suit or proceeding, whether civil, criminal, administrative or investigative, by reason of the fact that he is or was a director, employee, officer or agent of the Association, against expenses (including attorney's fees and appellate attorney's fees), judgments, fines and amounts paid in settlement actually and reasonably incurred by him in connection with such action, suit or proceeding, unless (a) a court of competent jurisdiction determines, after all available appeals have been exhausted or not pursued by the proposed indemnitee, that he did not act in good faith or in a manner he reasonably believed to be not in, or opposed to, the best interest of the Association, and, with respect to any criminal action or proceeding, that he had reasonable cause to believe his conduct was unlawful, and (b) such court further specifically determines that indemnification should be denied. The termination of any action, suit or proceeding by judgment, order,

settlement, conviction or upon plea of nolo contendere or its equivalent shall not, of itself, create a presumption that the person did not act in good faith or did act in a manner which he reasonably believed to be not in, or opposed to, the best interest of the Association, and, with respect to any criminal action or proceeding, that he had reasonable cause to believe that his conduct was unlawful.

- 11.2 Expenses. To the extent that a director, officer, employee or agent of the Association has been successful on the merits or otherwise in defense of any action, suit or proceeding referred to in Section 11.1 above, or in defense of any claim, issue or matter therein, he shall be indemnified against expenses (including attorney's fees and appellate attorneys' fees) actually and reasonably incurred by him in connection therewith.
- 11.3 Advances. Expenses incurred in defending a civil or criminal action, suit or proceeding shall be paid by the Association in advance of the final disposition of such action, suit or proceeding upon receipt of an undertaking by or on behalf of the affected director, officer, employee or agent to repay such amount unless it shall ultimately be determined that he is entitled to be indemnified by the Association as authorized in this Article 11.
- 11.4 Miscellaneous. The indemnification provided by this Article shall not be deemed exclusive of any other rights to which those seeking indemnification may be entitled under any by-law, agreement, vote of members or otherwise, and shall continue as to a person who has ceased to be a director, officer, employee or agent and shall inure to the benefit of the heirs and personal representatives of such person.
- 11.5 Insurance. The Association shall have the power to purchase and maintain insurance on behalf of any person who is or was a director, officer, employee or agent of the Association, or is or was serving, at the request of the Association, as a director, officer, employee or agent of another corporation, partnership, joint venture, trust or other enterprises, against any liability asserted against him and incurred by him in any such capacity, or arising out of his status as such, whether or not the Association would have the power to indemnify him against such liability under the provisions of this Article.
- 11.6 Amendment. Anything to the contrary herein notwithstanding, the provisions of this Article 11 may not be amended without the prior written consent of all persons whose interest would be adversely affected by such amendment.

ARTICLE 12

BY-LAWS

The first By-Laws of the Association shall be adopted by the Board of Directors and may be altered, amended or rescinded in the manner provided in the By-Laws and the Declaration.

ARTICLE 13

AMENDMENTS

Amendments to these Articles shall be proposed and adopted in the following manner:

- 13.1 Notice. Notice of a proposed amendment shall be included in the notice of any meeting at which the proposed amendment is to be considered and shall be otherwise given in the time and manner provided in Chapter 617, Florida Statutes. Such notice shall contain the proposed amendment or a summary of the changes to be affected thereby.
- 13.2 Adoption. Amendments shall be proposed and adopted in the manner provided in Chapter 617, Florida Statutes and in the Act (the latter to control over the former to the extent provided for in the Act).
- 13.3 Limitation. No amendment shall make any changes in the qualifications for membership, nor in the voting rights or property rights of members, nor any changes to Article 5 hereof, without the approval in writing of all members and the joinder of all record owners of mortgages upon Units. No amendment shall be made that is in conflict with the Act, the Declaration or the By-Laws, nor shall any amendment make any changes which would in any way affect any of the rights, privileges, powers or options herein provided in favor of or reserved to the Developer, or an affiliate of the Developer, unless the Developer shall join in the execution of the amendment. No amendment to this Section 13.3 shall be effective.
- 13.4 Developer Amendments. To the extent lawful, the Developer may amend these Articles consistent with the provisions of the Declaration allowing certain amendments to be effected by the Developer alone.
- 13.5 Recording. A copy of each amendment shall be filed with the Secretary of State pursuant to the provisions of applicable Florida law, and a copy certified by the Secretary of State shall be recorded in the Public Records of Duval County, Florida.

ARTICLE 14

INITIAL REGISTERED OFFICE; ADDRESS AND NAME OF REGISTERED AGENT

The initial registered office of this corporation shall be at 7001 Lake Ellenor Drive, Suite 200, Orlando, Florida 32809. The initial registered agent of this corporation is Anthony C. Martin.

IN WITNESS WHEREOF, the undersigned Incorporator has executed these Articles of Incorporation on September 6, 2005.

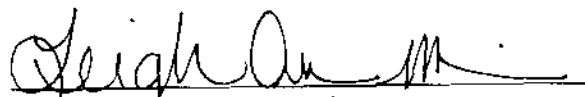
Name: Leigh Ann Murvin
Its: Incorporator

**CERTIFICATE DESIGNATING PLACE OF BUSINESS OR
DOMICILE FOR SERVICE OF PROCESS WITHIN THIS STATE, NAMING
AGENT UPON WHOM PROCESS MAY BE SERVED**

In compliance with the laws of Florida, the following is submitted:

That desiring to organize under the laws of the State of Florida with its principal office, as indicated in the foregoing Articles of Incorporation, in the City of Orlando, County of Orange, State of Florida, the corporation named in the said Articles has named Anthony C. Martin, located at 7001 Lake Ellenor Drive, Suite 200, Orlando, Florida 32809, as its statutory registered agent.

Having been named the statutory registered agent of said corporation, at the place designated in this certificate, I hereby accept the same and agree to act in this capacity, and further agree to comply with the provisions of Florida law relative to the proper and complete performance of my duties.

Dated this 2nd day of September, 2005.

By: 
Name: Anthony C. Martin
Its: Registered Agent

EXHIBIT "3"

BY-LAWS OF MIRABELLA I
CONDOMINIUM ASSOCIATION, INC.

**BY-LAWS
OF
MIRABELLA I CONDOMINIUM ASSOCIATION, INC.**

A corporation not for profit organized under the laws of the State of Florida

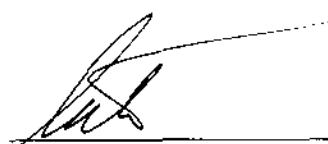
1. **Identity.** These are the By-Laws of **MIRABELLA I CONDOMINIUM ASSOCIATION, INC.**, a corporation not for profit incorporated under the laws of the State of Florida (the "Association"), and organized for the purpose of administering that certain condominium located in Duval County, Florida, and known as MIRABELLA, a Condominium (the "Condominium").
 - 1.1 **Principal Office.** The principal office of the Association shall be at 7001 Lake Ellenor Drive, Suite 200, Orlando, Florida 32809, or at such other place as may be subsequently designated by the Board of Directors. All books and records of the Association shall be kept in Orange County, Florida, or at such other place as may be permitted by the Act from time to time.
 - 1.2 **Fiscal Year.** The fiscal year of the Association shall be the calendar year. However, the Board of Directors of the Association is expressly authorized, whenever it deems advisable, to change to a different fiscal year.
 - 1.3 **Seal.** The seal of the Association shall bear the name of the corporation, the word "Florida," the words "Corporation Not for Profit," and the year of incorporation.
2. **Definitions.** For convenience, these By-Laws shall be referred to as the "By-Laws" and the Articles of Incorporation of the Association as the "Articles." The other terms used in these By-Laws shall have the same definitions and meanings as those set forth in the Declaration for the Condominium, unless herein provided to the contrary, or unless the context otherwise requires.
3. **Members.**
 - 3.1 **Annual Meeting.** The annual meeting of the members shall be held on the date, at the place and at the time determined by the Board of Directors from time to time, provided that there shall be an annual meeting every calendar year and, in no event, later than thirteen (13) months after the last annual meeting. The purpose of the meeting shall be, except as provided herein to the contrary, to elect Directors and to transact any other business authorized to be transacted by the members, or as stated in the notice of the meeting sent to Unit Owners in advance thereof.
 - 3.2 **Special Meetings.** Special meetings of the members shall be held at such places as provided herein for annual meetings, and may be called by the President or by a majority of the Board of Directors of the Association, and must be called by the President or Secretary upon receipt of a written request from a majority of the members of the Association. The business conducted at a special meeting shall be limited to that stated in the notice of the meeting. Special meetings may also be

called by Unit Owners in the manner provided for in the Act, including, but not limited to, the following: (i) a special meeting of the Unit Owners for purposes of recalling a member or members of the Board of Directors, in accordance with Section 718.112(2) of the Act, may be called by 10% of the voting interests giving notice of the special meeting as required for a meeting of unit owners, and (ii) such special meeting as provided for in Section 9 of these By-Laws.

- 3.3 **Notice of Meeting; Waiver of Notice.** Notice of a meeting of members (annual or special), specifically incorporating an identification of agenda items, stating the time and place and purpose(s) for which the meeting is called, shall be given by the President or Secretary. A copy of the notice shall be posted at a conspicuous place on the Condominium Property at least fourteen (14) continuous days preceding the annual meeting. The notice of the annual meeting shall be sent by mail to each Unit Owner, unless the Unit Owner waives in writing the right to receive notice of the annual meeting by mail. The delivery or mailing shall be to the address of the member as it appears on the roster of members. The posting and mailing of the notice for either special or annual meetings shall be effected not less than fourteen (14) continuous days prior to the date of the meeting. Proof of posting shall be given by affidavit, and proof of mailing of the notice shall be given by affidavit or the retention of a post office certificate of mailing.

Notice of specific meetings may be waived before or after the meeting and the attendance of any member (or person authorized to vote for such member), either in person or by proxy, shall constitute such member's waiver of notice of such meeting, except when his (or his authorized representative's) attendance is for the express purpose of objecting at the beginning of the meeting to the transaction of business because the meeting is not lawfully called.

An Officer of the Association, or the manager or other person providing notice of the meeting, shall provide an affidavit or postal service certificate of mailing, to be included in the official records of the Association, affirming that notices of the Association meeting were posted and mailed in accordance with this Section and Section 718.112(2)(d) of the Act, to each Unit Owner at the address last furnished to the Association. No other proof of notice of a meeting shall be required.

- 3.4 **Quorum.** A quorum at meetings of members shall be attained by the presence, either in person or by proxy, of persons entitled to cast in excess of 33-1/3% of the votes of the members entitled to vote at the subject meeting.

3.5 **Voting.**

(a) **Number of Votes.** Each Unit shall have the number of votes set forth in the Declaration. The vote of a Unit shall not be divisible.

(b) **Majority Vote.** The acts approved by a majority of the votes present in person or by proxy at a meeting at which a quorum shall have been attained shall be binding upon all Unit Owners for all purposes, except where otherwise provided by law, the Declaration, the Articles or these By-Laws. As used in these

By-Laws, the Articles or the Declaration, the terms "majority of the Unit Owners" and "majority of the members" shall mean a majority of the votes entitled to be cast by the members and not a majority of the members themselves and shall further mean more than 50% of the then total authorized votes present in person or by proxy and voting at any meeting of the Unit Owners at which a quorum shall have been attained. Similarly, if some greater percentage of members is required herein or in the Declaration or Articles, it shall mean such greater percentage of the votes of members and not of the members themselves.

(c) Voting Member. If a Unit is owned by one person, that person's right to vote shall be established by the roster of members. If a Unit is owned by more than one person, those persons (including husbands and wives) shall decide among themselves as to who shall cast the vote of the Unit. In the event that those persons cannot so decide, no vote shall be cast. A person casting a vote for a Unit shall be presumed to have the authority to do so unless the President or the Board of Directors is otherwise notified. If a Unit is owned by a corporation, trust or limited liability company, the person entitled to cast the vote for the Unit shall be designated by a certificate signed by an appropriate Officer of the corporation, trustee of the trust or manager of the limited liability company and filed with the Secretary of the Association. Such person need not be a Unit Owner. Those certificates shall be valid until revoked or until superseded by a subsequent certificate or until a change in the ownership of the Unit concerned. A certificate designating the person entitled to cast the vote for a Unit may be revoked by any record owner of an undivided interest in the Unit. If a certificate designating the person entitled to cast the vote for a Unit for which such certificate is required is not on file or has been revoked, the vote attributable to such Unit shall not be considered in determining whether a quorum is present, nor for any other purpose, and the total number of authorized votes in the Association shall be reduced accordingly until such certificate is filed.

- 3.6 Proxies. Votes may be cast in person or by limited proxy. A proxy may be made by any person entitled to vote, but shall only be valid for the specific meeting for which originally given and any lawfully adjourned meetings thereof. All proxies must be filed with the Secretary before the appointed time of each meeting and such proxy shall be valid only for the particular meeting designated in the proxy and any lawfully adjourned meeting thereof. In no event shall any proxy be valid for a period longer than ninety (90) days after the date of the first meeting for which it was given. Every proxy shall be revocable at any time at the pleasure of the person executing it. A proxy must be in writing, signed by the person authorized to cast the vote for the Unit (as above described), name the person(s) voting by proxy and the person authorized to vote for such person(s). Each proxy shall contain the date, time and place of the meeting for which it is given and shall set forth the matters on which the proxy holder may vote and the manner in which the vote is to be cast. Holders of proxies need not be Unit Owners. No proxy shall be used in the election of Board members, either in general elections or elections to fill vacancies caused by recall, resignation or otherwise except as may be otherwise provided by the Act.

- 3.7 **Adjourned Meetings.** If any proposed meeting cannot be organized because a quorum has not been attained, the members who are present, either in person or by proxy, may adjourn the meeting from time to time until a quorum is present, provided notice of the newly scheduled meeting is given in the manner required for the giving of notice of a meeting. Except as required above, proxies given for the adjourned meeting shall be valid for the newly scheduled meeting unless revoked for reasons other than the new date of the meeting.
- 3.8 **Order of Business.** If a quorum has been attained, the order of business at annual members' meetings, and, if applicable, at other members' meetings, shall be:
- (a) Call to order by President;
 - (b) Collect ballots not yet cast;
 - (c) Appointment by the President of a chairman of the meeting (who need not be a member or a Director);
 - (d) Appointment of inspectors of election;
 - (e) Election of Directors;
 - (f) Proof of notice of the meeting or waiver of notice;
 - (g) Reading of minutes;
 - (h) Reports of Officers;
 - (i) Reports of committees;
 - (j) Unfinished business;
 - (k) New business;
 - (l) Adjournment.

Such order may be waived in whole or in part by direction of the chairman.

- 3.9 **Minutes of Meetings.** The minutes of all meetings of Unit Owners shall be kept in a book available for inspection by Unit Owners or their authorized representatives and Board members at any reasonable time. The Association shall retain these minutes for a period of not less than seven (7) years.
- 3.10 **Action Without a Meeting.** Anything to the contrary herein notwithstanding, to the extent lawful, any action required to be taken at any annual or special meeting of members, or any action which may be taken at any annual or special meeting of such members, may be taken without a meeting, without prior notice and without a vote if a consent in writing, setting forth the action so taken, shall be signed by the members (or persons authorized to cast the vote of any such members as

elsewhere herein set forth) having not less than the minimum number of votes that would be necessary to authorize or take such action at a meeting of members at which a quorum of members (or authorized persons) entitled to vote thereon were present and voted. Within ten (10) days after obtaining such authorization by written consent, notice must be given to members who have not consented in writing. The notice shall fairly summarize the material features of the authorized action.

- 3.11 **Mandatory Non-Binding Arbitration.** Prior to the institution of court litigation, the parties to a dispute, as defined pursuant to Section 718.1255, Florida Statutes, as amended from time to time, shall petition the Division for non-binding arbitration. Arbitration shall be conducted according to rules promulgated by the Division and Section 718.1255, Florida Statutes.

4. **Directors.**

- 4.1 **Membership.** The affairs of the Association shall be governed by a Board of not less than three (3) Directors, the exact number to be determined in the first instance in the Articles, and, thereafter, except as provided herein, from time to time upon majority vote of the membership; provided, however, that the number of Directors shall always be an odd number. During Developer control, Directors need not be Unit Owners; however, upon turnover, Directors shall be Unit Owners. Directors may not vote at Board meetings by proxy or by secret ballot. When Unit Owners other than OMNI-TIVOLI, LLC, a Florida limited liability company, its successors or assigns (the "Developer") own fifteen percent (15%) or more of the Units that will be operated ultimately by the Association, such Unit Owners, other than the Developer, shall be entitled to elect no less than one-third (1/3) of the members of the Board of Directors.

Such Unit Owners, other than the Developer, are entitled to elect not less than a majority of the members of the Board:

- (a) Three (3) years after fifty percent (50%) of the Units that will be operated ultimately by the Association have been conveyed to purchasers;
- (b) Three (3) months after ninety percent (90%) of the Units that will be operated ultimately by the Association have been conveyed to purchasers;
- (c) When all of the Units that will be operated ultimately by the Association have been completed, some of them have been conveyed to purchasers, and none of the others are being offered for sale by the Developer in the ordinary course of business;
- (d) When some of the Units have been conveyed to purchasers and none of the others are being constructed or offered for sale by the Developer in the ordinary course of business; or
- (e) Seven (7) years after recordation of the Declaration.

BL5

Developer shall have the right to elect a majority of the Board until the first occurrence of any of the above events. Developer is entitled to elect at least one (1) Director as long as Developer holds for sale in the ordinary course of business at least five percent (5%) of the Units in the Condominium. Following the time the Developer relinquishes control of the Association, the Developer may exercise the right to vote any Developer owned Units in the same manner as any other Unit Owner except for purposes of reacquiring control of the Association or selecting the majority members of the Board. The right reserved herein to Developer to elect and maintain Directors may be exercised by its successor(s) in interest.

4.2 **Election of Directors.** The election of Directors shall be conducted in the following manner:

- (a) Election of Directors shall be held at the annual meeting of members, except as provided herein to the contrary.
- (b) Not less than sixty (60) days before a scheduled election, the Association shall mail or deliver, whether by separate Association mailing or included in another Association mailing or delivery including regularly published newsletters, to each Unit Owner entitled to vote, a first notice of the date of the election. Such first notice must contain the name and correct mailing address of the Secretary of the Association or person designated by the Secretary of the Association. Any Unit Owner or other eligible person desiring to be a candidate for the Board of Directors shall give written notice to the Secretary of the Association not less than forty (40) days before a scheduled election. Together with the written notice and agenda as set forth in Section 718.112(2)(d), Florida Statutes, the Association shall then mail or deliver a second notice of the election to all Unit Owners entitled to vote therein, together with a ballot which shall list all candidates. Upon request of a candidate, the Association shall include an information sheet, no larger than 8 and ½ inches by 11 inches which must be furnished by the candidate not less than thirty-five (35) days before the election, to be included with the mailing of the ballot, with the costs of mailing or delivery and copying to be borne by the Association. However, the Association has no liability for the contents of information sheets prepared by candidates. In order to reduce costs, the Association may print or duplicate the information sheets on both sides of the paper.
- (c) The election shall be by written ballot or voting machine, and by a plurality of the votes cast, each person being entitled to cast his vote for each of as many nominees as there are vacancies to be filled. There shall be no cumulative voting. There shall be no quorum requirement or minimum number of votes necessary for election of the Board of Directors; however, at least 20% of the eligible voters must cast a ballot in order to have a valid election of members of the Board of Directors.

- (d) Notwithstanding the provisions of this paragraph 4.2, an election is not required unless more candidates file notices of intent to run or are nominated than vacancies exist on the Board.

4.3 **Vacancies and Removal.**

- (a) Except as to vacancies resulting from removal of Directors by members, vacancies in the Board of Directors occurring between annual meetings of members shall be filled by the remaining Directors, provided that all vacancies in Directorships to which Directors were appointed by the Developer pursuant to the provisions of paragraph 4.16 hereof shall be filled by the Developer without the necessity of any meeting.
- (b) Any Director elected by the members (other than the Developer) may be removed from office, with or without cause, by concurrence of a majority of the votes of all the voting interests at a special meeting of members called for that purpose, which meeting may be called by 10% of the voting interests, giving notice of the meeting as required for a meeting of Unit Owners, and stating the purpose of the meeting, or by written agreement signed by a majority of the Owners of all Units other than the Developer.

If the recall is approved by a majority of all voting interests by a vote at a meeting, the recall will be effective as provided herein. The Board shall duly notice and hold a Board meeting within five (5) full business days of the adjournment of the Unit Owner meeting to recall one or more Board members. At the meeting, the Board shall either certify the recall, in which case such member or members shall be recalled effective immediately and shall turn over to the Board within five (5) full business days any and all records and property of the Association in their possession, or shall proceed as set forth below regarding procedures where the Board has not certified the recall.

If the proposed recall is by an agreement in writing by a majority of all voting interests, the agreement in writing or a copy thereof shall be served on the Association by certified mail or by personal service in the manner authorized by Chapter 48, Florida Statutes, and the Florida Rules of Civil Procedure. The Board of Directors shall duly notice and hold a meeting of the Board within five (5) full business days after receipt of the agreement in writing. At the meeting, the Board shall either certify the written agreement to recall a member or members of the Board, in which case such member or members shall be recalled effective immediately and shall turn over to the Board within five (5) full business days any and all records and property of the Association in their possession, or proceed as described below.

If the Board determines not to certify the written agreement to recall a member or members of the Board, or does not certify the recall by a vote at a meeting, the Board shall, within five (5) full business days after the

BL7

meeting, file with the Division a petition for arbitration pursuant to the procedures in Section 718.1255 of the Act. For the purposes of this section, the Unit Owners who voted at the meeting or who executed the agreement in writing shall constitute one party under the petition for arbitration. If the arbitrator certifies the recall as to any member or members of the Board, the recall will be effective upon mailing of the final order of arbitration to the Association. If the Association fails to comply with the order of the arbitrator, the Division may take action pursuant to Section 718.501 of the Act. Any member or members so recalled shall deliver to the Board any and all records of the Association in their possession within five (5) full business days of the effective date of the recall.

If the Board fails to duly notice and hold a Board meeting within five (5) full business days of service of an agreement in writing or within five (5) full business days of the adjournment of the Unit Owner recall meeting, the recall shall be deemed effective and the Board members so recalled shall immediately turn over to the Board any and all records and property of the Association.

If a vacancy occurs on the Board as a result of a recall and less than a majority of the Board members are removed, the vacancy may be filled by the affirmative vote of a majority of the remaining Directors, notwithstanding any provision to the contrary contained in Section 4 herein. If vacancies occur on the Board as a result of a recall and a majority or more of the Board members are removed, the vacancies shall be filled in accordance with procedural rules to be adopted by the Division.

- (c) Anything to the contrary herein notwithstanding, until a majority of the Directors are elected by the members other than the Developer of the Condominium, neither the first Directors of the Association, nor any Directors replacing them, nor any Directors named by the Developer, shall be subject to removal by members other than the Developer. The first Directors and Directors replacing them may be removed and replaced by the Developer without the necessity of any meeting.
- (d) If the Association's failure to fill vacancies on the Board of Directors results in the inability to obtain a quorum of Directors in accordance with these By-Laws, any Owner may apply to the Circuit Court within whose jurisdiction the Condominium lies for the appointment of a receiver to manage the affairs of the Association. At least thirty (30) days prior to applying to the Circuit Court, the Unit Owner shall mail to the Association and post in a conspicuous place on the Condominium Property a notice describing the intended action and giving the Association an opportunity to fill the vacancy(ies) in accordance with these By-Laws. If, during such time, the Association fails to fill the vacancy(ies), the Unit Owner may

proceed with the petition. If a receiver is appointed, the Association shall be responsible for the salary of the receiver, court costs and attorneys' fees. The receiver shall have all powers and duties of a duly constituted Board of Directors, and shall serve until the Association fills the vacancy(ies) on the Board sufficient to constitute a quorum in accordance with these By-Laws.

- 4.4 **Term.** Except as provided herein to the contrary, the term of each Director's service shall extend until the next annual meeting of the members and subsequently until his successor is duly elected and has taken office, or until he is removed in the manner elsewhere provided. Notwithstanding the foregoing, any Director designated by the Developer shall serve at the pleasure of the Developer and may be removed and replaced by the Developer at any time.
- 4.5 **Organizational Meeting.** The organizational meeting of newly-elected or appointed Directors shall be held within ten (10) days of their election or appointment at such place and time as shall be fixed by the Directors at the meeting at which they were elected or appointed. The organizational meeting shall be noticed in the same manner as the regular meeting of the Board of Directors.
- 4.6 **Regular Meetings.** Regular meetings of the Board of Directors may be held at such time and place as shall be determined, from time to time, by a majority of the Directors. Notice of regular meetings which specifically incorporates an identification of agenda items shall be given to each Director, personally or by mail, telephone or telegraph, and shall be transmitted at least forty-eight (48) hours prior to the meeting. Regular meetings of the Board of Directors shall be open to all Unit Owners and notice of such meetings, which notice shall specifically incorporate an identification of agenda items, shall be posted conspicuously on the Condominium Property at least forty-eight (48) continuous hours in advance for the attention of the members of the Association, except in the event of an emergency. Such meetings shall be open to all Unit Owners and Unit Owners shall have the right to speak with reference to all designated agenda items. The Board may adopt reasonable rules governing the frequency, duration and manner of Unit Owner statements. Unit Owners may tape record or videotape meetings of the Board in accordance with the rules of the Division. Directors may not vote by proxy or secret ballot at Board meetings. A vote or abstention of each Director present shall be recorded in the minutes.

A Director who is present at a meeting of the Board at which action on any corporate matter is taken shall be presumed to have assented to the action taken, unless that Director votes against such action or abstains from voting in respect thereto, because of an asserted conflict of interest.

- 4.7 **Special Meetings.** Special meetings of the Directors may be called by the President, and must be called by the President or Secretary at the written request of one-third (1/3) of the Directors. For so long as the Developer is in control of the Association, special meetings of the Directors may be called by the

BL9

Developer. Notice of the meeting shall be given personally or by mail, telephone or telegraph, which notice shall state the time, place and purpose of the meeting, and shall be transmitted not less than forty-eight (48) hours prior to the meeting. Special meetings of the Board of Directors shall be open to all Unit Owners, and notice of such meetings, which notice shall specifically incorporate an identification of agenda items, shall be posted conspicuously on the Condominium Property at least forty-eight (48) continuous hours in advance for the attention of the members of the Association except in the event of an emergency, and Unit Owners shall have a reasonable right to participate. The Board may adopt reasonable rules governing the frequency, duration and manner of Unit Owner statements. Unit Owners may tape record or videotape meetings of the Board in accordance with the rules of the Division. Directors may not vote by proxy or secret ballot at Special Meetings. A vote or abstention for each Director present shall be recorded in the Minutes.

Notwithstanding the foregoing, written notice of any meeting of the Board at which non-emergency special assessments, or at which amendment to rules regarding Unit use will be considered shall be mailed or delivered to the Unit Owners and posted conspicuously on the Condominium Property not less than fourteen (14) days prior to the meeting.

- 4.8 **Waiver of Notice.** Any Director may waive notice of a meeting before or after the meeting and that waiver shall be deemed equivalent to the due receipt by said Director of notice. Attendance by any Director at a meeting, except when his attendance is for the express purpose of objecting at the beginning of the meeting to the transaction of business because the meeting is not lawfully called, shall be deemed equivalent to the due receipt by said Director of notice.
- 4.9 **Quorum.** A quorum of Directors' meetings shall consist of a majority of the entire Board of Directors. The acts approved by a majority of those present at a meeting at which a quorum is present shall constitute the acts of the Board of Directors, except when approval by a greater number of Directors is specifically required by the Declaration, the Articles or these By-Laws.

Meetings of the Board of Directors and any committee thereof at which a quorum of the members of that committee are present shall be open to all Unit Owners. The right to attend such meetings includes the right to speak with reference to all designated agenda items; provided, however, the Association may adopt reasonable rules governing the frequency, duration and manner of Unit Owner statements. Unit Owners shall have the right to tape record or videotape the meetings of the Board of Directors, subject to reasonable rules adopted by the Division.

- 4.10 **Adjourned Meetings.** If, at any proposed meeting of the Board of Directors, there is less than a quorum present, the majority of those present may adjourn the meeting from time to time until a quorum is present, provided notice of such newly scheduled meeting is given as required hereunder. At any newly scheduled

meeting, any business that might have been transacted at the meeting as originally called may be transacted.

- 4.11 **Joinder in Meeting by Approval or Disapproval of Minutes.** The joinder of a Director in the action of a meeting by signing and concurring in the minutes of that meeting shall constitute the approval or disapproval of that Director of the business conducted at the meeting, but such joinder by agreement or disagreement may not be used as a vote for or against the action taken and may not be used for the purposes of creating a quorum.
- 4.12 **Presiding Office.** The presiding Officer at the Directors' meetings shall be the President or, in his absence, the Vice President, and in his absence, the Directors present shall designate any of their number to preside.
- 4.13 **Order of Business.** If a quorum has been attained, the order of business at Directors' meetings shall be:
- (a) Election of Chairman;
 - (b) Roll Call;
 - (c) Proof of due notice of meeting;
 - (d) Reading and disposal of any unapproved minutes;
 - (e) Reports of Officers and committees;
 - (f) Election of Inspectors of Election;
 - (g) Election of Officers;
 - (h) Unfinished business;
 - (i) New Business;
 - (j) Adjournment.

Such order may be waived in whole or in part by direction of the presiding Officer.

- 4.14 **Minutes of Meetings.** The minutes of all meetings of the Board of Directors shall be kept in a book available for inspection by Unit Owners, or their authorized representatives, and Board members at any reasonable time. The Association shall retain minutes of all meetings of the Board of Directors for a period of not less than seven (7) years.
- 4.15 **Executive Committee; Other Committees.** The Board of Directors may, by resolution duly adopted, appoint an Executive Committee to consist of three (3) or more members of the Board of Directors. Such Executive Committee shall have

and may exercise all of the powers of the Board of Directors in management of the business and affairs of the Condominium during the period between the meetings of the Board of Directors insofar as may be permitted by law, except that the Executive Committee shall not have power to (a) determine the Common Expenses required for the affairs of the Condominium, (b) determine the Assessments payable by the Unit Owners to meet the Common Expenses of the Condominium, (c) adopt or amend any rules and regulations covering the details of the operation and use of the Condominium Property, or (d) exercise any of the powers set forth in paragraphs (f), (g), (h), (n) and (o) of Section 5 below.

The Board may by resolution also create other committees and appoint persons to such committees and vest in such committees such powers and responsibilities as the Board shall deem advisable. Such other committees shall have and may exercise all of the powers of the Board of Directors in management of the business and affairs of the Condominium during the period between the meetings of the Board of Directors insofar as may be permitted by law, except that such other committees shall not have power to (a) determine the Common Expenses required for the affairs of the Condominium, (b) determine the Assessments payable by the Unit Owners to meet the Common Expenses of the Condominium, (c) adopt or amend any rules and regulations covering the details of the operation and use of the Condominium Property, or (d) exercise any of the powers set forth in paragraphs (f), (g), (h), (n) and (o) of Section 5 below.

Meetings of any committee of the Board at which a quorum of the members of that committee are present shall be open to all Unit Owners. Written notice, which notice shall specifically incorporate an identification of agenda items, of all committee meetings shall be posted conspicuously on the Condominium Property at least forty-eight (48) continuous hours preceding the meeting, except in an emergency.

- 4.16 **Proviso.** Notwithstanding anything to the contrary contained in this Section 4 or otherwise, the Board shall consist of three Directors during the period that the Developer is entitled to appoint a majority of the Directors, as hereinafter provided. The Developer shall have the right to appoint all of the members of the Board of Directors until Unit Owners other than the Developer own 15% or more of the Units that will be operated ultimately by the Association. When Unit Owners other than the Developer own 15% or more of the Units that will be operated ultimately by the Association, the Unit Owners other than the Developer shall be entitled to elect not less than one-third (1/3) of the members of the Board of Directors. Upon the election of such Director(s), the Developer shall forward to the Division of Land Sales, Condominiums and Mobile Homes the name and mailing address of the Director(s) elected. Unit Owners other than the Developer are entitled to elect not less than a majority of the members of the Board of Directors (a) three years after 50% of the Units that will be operated ultimately by the Association have been conveyed to purchasers; (b) three months after 90% of the Units that will be operated ultimately by the Association have been conveyed to the purchasers; (c) when all of the Units that will be operated ultimately by the

Association have been completed, some of them have been conveyed to purchasers, and none of the others are being offered for sale by the Developer in the ordinary course of business; (d) when some of the Units have been conveyed to purchasers, and none of the others are being constructed or offered for sale by the Developer in the ordinary course of business, or (e) seven (7) years after recordation of the Declaration of Condominium in the public records, whichever occurs first. The Developer is entitled (but not obligated) to elect at least one (1) member of the Board of Directors as long as the Developer holds for sale in the ordinary course of business at least 5% of the Units in the Condominium that ultimately will be operated by the Association. Following the time the Developer relinquishes control of the Association, the Developer may exercise the right to vote any Developer owned Units in the same manner as any other Unit Owners except for purposes of reacquiring control of the Association or selecting the majority of members of the Board of Directors.

The Developer can voluntarily turn over control of the Association to Unit Owners other than the Developer prior to the dates specified herein, in its sole discretion, by causing all of its appointed Directors to resign, whereupon it shall be the affirmative obligation of Unit Owners other than the Developer to elect Directors and assume control of the Association. Provided at least seventy-five (75) days' notice of Developer's decision to cause its appointees to resign is given to Unit Owners, neither the Developer, nor such appointees, shall be liable in any manner in connection with such resignations even if the Unit Owners other than the Developer refuse or fail to assume control.

Within seventy-five (75) days after the Unit Owners other than the Developer are entitled to elect a member or members of the Board of Directors, or sooner if the Developer has elected to accelerate such event as aforesaid, the Association shall call, and give not less than sixty (60) days' notice of a meeting of the Unit Owners to elect such member or members of the Board of Directors. The election shall proceed as herein before provided for the election of Directors in paragraph 4.2 hereof. The meeting may be called and the notice given by any Unit Owner if the Association fails to do so.

At the time that Unit Owners other than the Developer elect a majority of the members of the Board of Directors of the Association, the Developer shall relinquish control of the Association and such Unit Owners shall accept control. At that time, Developer shall deliver to the Association all property of the Unit Owners and of the Association held or controlled by the Developer, including, but not limited to, the following items, if applicable:

- (a) The original or a photocopy of the recorded Declaration of Condominium, and all amendments thereto. If a photocopy is provided, the Developer must certify by affidavit that it is a complete copy of the actual recorded Declaration.
- (b) A certified copy of the Articles of Incorporation of the Association.

- (c) A copy of the By-Laws of the Association.
- (d) The minute books, including all minutes, and other books and records of the Association.
- (e) Any rules and regulations which have been promulgated.
- (f) Resignations of resigning Officers and Board members who were appointed by the Developer.
- (g) Association funds or the control thereof.
- (h) All tangible personal property that is the property of the Association which is or was represented by the Developer to be part of the Common Elements or is ostensibly part of the Common Elements, and an inventory of such property.
- (i) A copy of the plans and specifications utilized in the construction or remodeling of Improvements and the supplying of equipment and for the construction and installation of all mechanical components serving the Improvements and the Condominium Property, with a certificate, in affidavit form, of the Developer or the Developer's agent or an architect or engineer authorized to practice in Florida, that such plans and specifications represent, to the best of his knowledge and belief, the actual plans and specifications utilized in the construction and improvement of the Condominium Property and for the construction and installation of the mechanical components serving the Improvements and the Condominium Property.
- (j) A list of the names and addresses, of which the Developer had knowledge at any time in the development of the Condominium, of all contractors, subcontractors, and suppliers utilized in the construction or remodeling of the Improvements and in the landscaping of the Condominium or Association property.
- (k) Insurance policies.
- (l) Copies of all Certificates of Occupancy which may have been issued for the Condominium Property.
- (m) Any other permits issued by governmental bodies applicable to the Condominium Property in force or issued within one (1) year prior to the date the Unit Owners take control of the Association.
- (n) All written warranties of contractors, subcontractors, suppliers and manufacturers, if any, that are still effective.
- (o) A roster of Unit Owners and their addresses and telephone numbers, if known, as shown on the Developer's records.

- (p) Leases of the Common Elements and other leases to which the Association is a party, if applicable.
- (q) Employment contracts or service contracts in which the Association is one of the contracting parties, or service contracts in which the Association or Unit Owners have an obligation or responsibility, directly or indirectly, to pay some or all of the fee or charge of the person or persons performing the service.
- (r) All other contracts to which the Association is a party.

Within ninety (90) days after Unit Owners other than the Developer elect a majority of members of the Board of Directors of the Association, the Developer shall deliver the financial records, including financial statements of the Association, and source documents from the incorporation of the Association through the date of turnover. The records shall be audited for the period from the incorporation of the Association or from the period covered by the last audit, if an audit has been performed for each fiscal year since incorporation, by an independent certified public accountant. All financial statements shall be prepared in accordance with generally accepted accounting principles and shall be audited in accordance with generally accepted auditing standards, as prescribed by the Florida Board of Accountancy, pursuant to Chapter 473 of the Florida Statutes. The accountant performing the audit shall examine to the extent necessary supporting documents and records, including the cash disbursements and related paid invoices to determine if expenditures were for Association purposes and the billings, cash receipts, and related records to determine that the Developer was charged and paid the proper amounts of Assessments.

5. **Powers and Duties.** The Board of Directors shall have the powers and duties granted to it by law, the Declaration, the Act, the Articles, and these By-Laws necessary for the administration of the affairs of the Condominium and may take all acts, through the proper Officers of the Association, in executing such powers, except such acts which by law, the Declaration, the Articles or these By-Laws may not be delegated to the Board of Directors by the Unit Owners. Such powers and duties of the Board of Directors shall include, without limitation (except as limited elsewhere herein), the following:

- (a) Operating and maintaining the Common Elements and Association Property.
- (b) Determining the expenses required for the operation of the Condominium and the Association.
- (c) Employing and dismissing the personnel necessary for the maintenance and operation of the Common Elements.
- (d) Adopting and amending rules and regulations concerning the details of the operation and use of the Units, the Condominium Property and

Association Property, subject to a right of the Unit Owners to overrule the Board as provided in Section 13 hereof.

- (e) Maintaining bank accounts on behalf of the Association and designating the signatory or signatories required therefor.
- (f) Purchasing, leasing or otherwise acquiring Units or other property in the name of the Association, or its designee.
- (g) Purchasing Units at foreclosure or other judicial sales, in the name of the Association, or its designee.
- (h) Selling, leasing, mortgaging or otherwise dealing with Units acquired, and subleasing Units leased, by the Association, or its designee.
- (i) Organizing corporations and appointing persons to act as designees of the Association in acquiring title to or leasing Units or other property.
- (j) Obtaining and reviewing insurance for the Condominium Property and Association Property.
- (k) Making repairs, additions and improvements to, or alterations of, Condominium Property and Association Property, and repairs to and restoration of the Condominium Property and Association Property, in accordance with the provisions of the Declaration after damage or destruction by fire or other casualty, or as a result of condemnation or eminent domain proceedings or otherwise.
- (l) Enforcing obligations of the Unit Owners, allocating profits and expenses and taking such other actions as shall be deemed necessary and proper for the sound management of the Condominium.
- (m) Levying reasonable fines against appropriate Unit Owners for violations by the Unit Owners, their occupants, licensees or invitees of the Declaration, these By-Laws, or the rules and regulations established by the Association. No fine shall exceed the highest amount permitted under the Act (as it may be amended from time to time). However, a fine may be levied on the basis of each day of a continuing violation, provided that the maximum fine shall not exceed the aggregate maximum permitted under the Act (as it may be amended from time to time). No fine shall be levied except after giving reasonable notice and opportunity for a hearing to the affected Unit Owner and, if applicable, his tenant, licensee or invitee. Such hearing shall be held before a committee of other Unit Owners. No fine shall become a lien upon a Unit, unless permitted by the Act (as it may be amended from time to time) or by the Declaration.
- (n) Purchasing or leasing Units for use by resident superintendents and other similar persons.

- (o) Borrowing money on behalf of the Condominium or the Association when required in connection with the operation, care, upkeep and maintenance of the Common Elements or the acquisition of property, and granting mortgages on and/or security interests in Association owned property; provided, however, that the consent of the Owners of at least 75% of the Units represented at a meeting at which a quorum has been attained in accordance with the provisions of these By-Laws shall be required for the borrowing of any sum which would cause the total outstanding indebtedness of the Association to exceed \$10,000.00. If any sum borrowed by the Board of Directors on behalf of the Condominium pursuant to the authority contained in this subparagraph (o) is not repaid by the Association, a Unit Owner who pays to the creditor such portion thereof as his interest in his Common Elements bears to the interest of all of the Unit Owners in the Common Elements shall be entitled to obtain from the creditor a release of any judgment or other lien which said creditor shall have filed or shall have the right to file against, or which will affect, such Unit Owner's Unit; provided always, however, the Association shall take no action authorized in this paragraph without the prior written consent of the Developer as long as the Developer owns any Unit.
- (p) Contracting for the management and maintenance of the Condominium Property and Association Property and authorizing a management agent (who may be an affiliate of the Developer) to assist the Association in carrying out its powers and duties by performing such functions as the submission of proposals, collection of Assessments, preparation of records, enforcement of rules and maintenance, repair, and replacement of the Common Elements with such funds as shall be made available by the Association for such purposes. The Association and its Officers shall, however, retain at all times the powers and duties granted by the Condominium documents and the Act, including, but not limited to, the making of Assessments, promulgation of rules and execution of contracts on behalf of the Association.
- (q) To enforce by legal means the provisions of the Act, the Declaration of the Articles of Incorporation, these By-Laws, and the Rules and Regulations for the use of the Condominium Property.
- Notwithstanding the foregoing, in the event that a lawsuit is to be brought against the Developer for any reason whatsoever, seventy-five percent (75%) of the membership must agree, at a meeting duly called for such purpose, prior to institution of any such litigation.
- (r) At its discretion, but within the parameters of the Act, authorizing Unit Owners or other persons to use portions of the Common Elements or Association Property for private parties and gatherings and imposing reasonable charges for such private use.

- (s) Exercising (i) all powers specifically set forth in the Declaration, the Articles, these By-Laws and in the Act, (ii) all powers incidental thereto, and (iii) all other powers of a Florida corporation not for profit.
- (t) Contracting with and creating or joining in the creation of special taxing districts, joint councils and the like.
- (u) Acquiring and conveying Common Elements for the purposes of providing utility easements, right-of-way expansion or other public purpose whether negotiated or as part of the eminent domain procedure which authority can be exercised by the Board of Directors without approval of the Unit Owners.

6. Officers.

- 6.1 **Executive Officers.** The executive Officers of the Association shall be a President, a Vice-President, a Treasurer and a Secretary (none of whom need be Directors), all of whom shall be elected by the Board of Directors (which may create and fill other offices as provided herein) and who may be peremptorily removed at any meeting by concurrence of a majority of all the Directors. A person may hold more than one office, except that the President may not also be the Secretary. No person shall sign an instrument or perform an act in a capacity of more than one office. The Board of Directors from time to time shall elect such other Officers and designate their powers and duties as the Board shall deem necessary or appropriate to manage the affairs of the Association. Officers, other than designees of the Developer, must be Unit Owners (or authorized representatives of corporate/partnership/trust Unit Owners).
- 6.2 **President.** The President shall be the chief executive Officer of the Association. He shall have all of the powers and duties that are usually vested in the office of president of an association.
- 6.3 **Vice-President.** The Vice-President shall exercise the powers and perform the duties of the President in the absence or disability of the President. He also shall assist the President and exercise such other powers and perform such other duties as are incident to the office of the vice president of an association and as may be required by the Directors or the President.
- 6.4 **Secretary.** The Secretary shall keep the minutes of all proceedings of the Directors and the members. He shall attend to the giving of all notices to the members and Directors and other notices required by law. He shall have custody of the seal of the Association and shall affix it to instruments requiring the seal when duly signed. He shall keep the records of the Association, except those of the Treasurer, and shall perform all other duties incident to the office of the secretary of an association and as may be required by the Directors or the President.

- 6.5 **Treasurer.** The Treasurer shall have custody of all property of the Association, including funds, securities and evidences of indebtedness. He shall keep books of account for the Association in accordance with good accounting practices, which, together with substantiating papers, shall be made available to the Board of Directors for examination at reasonable times. He shall submit a treasurer's report to the Board of Directors at reasonable intervals and shall perform all other duties incident to the office of treasurer and as may be required by the Directors or the President. All monies and other valuable effects shall be kept for the benefit of the Association in such depositories as may be designated by a majority of the Board of Directors.
- 6.6 **Additional Offices.** The Board of Directors may create additional offices from time to time and appoint persons to fill such offices, subject to removal at the discretion of the Board.
- 6.7 **Developer Appointees.** No Officer appointed by the Directors may be removed except as provided in paragraph 4.16 hereof and by law.
7. **Compensation.** Neither Directors nor Officers shall receive compensation for their services as such, but this provision shall not preclude the Board of Directors from employing a Director or Officer as an employee of the Association, nor preclude contracting with a Director or Officer for the management of the Condominium or for any other service to be supplied by such Director or Officer. Directors and Officers shall be compensated for all actual and proper out-of-pocket expenses relating to the proper discharge of their respective duties.
8. **Resignations.** Any Director or Officer may resign his post at any time by written resignation, delivered to the President or Secretary, which shall take effect upon its receipt unless a later date is specified in the resignation, in which event the resignation shall be effective from such date unless withdrawn. The acceptance of a resignation shall not be required to make it effective. The conveyance of all Units owned by any Director or Officer (other than appointees of the Developer or Officers who were not Unit Owners) shall constitute a written resignation of such Director or Officer.
9. **Fiscal Management.** The provisions for fiscal management of the Association set forth in the Declaration and Articles shall be supplemented by the following provisions:
- 9.1 **Budget.**
- (a) **Adoption by Board; Items.** The Board of Directors shall from time to time, and at least annually, prepare a budget for the Condominium (which shall detail all accounts and items of expense and contain at least all items set forth in Section 718.504 (21) of the Act, if applicable), determine the amount of Assessments payable by the Unit Owners to meet the expenses of such Condominium and allocate and assess such expenses among the Unit Owners in accordance with the provisions of the Declaration. In addition to annual operating expenses, the budget shall include reserve accounts for capital expenditures and deferred maintenance (to the extent

required by law). These accounts shall include, but not be limited to, roof replacement, building painting, and pavement resurfacing. The amount of reserves shall be computed by means of a formula which is based upon the estimated remaining useful life and the estimated replacement cost of each reserve item. However, prior to turnover of control of the Association by the Developer pursuant to Section 718.301 of the Act, the Developer may vote to waive the reserves or reduce the funding of reserves for the first two years of operation of the Association, after which time reserves may only be waived or reduced upon the vote of a majority of all non-developer voting interests voting in person or by limited proxy at a duly called meeting of the Association. If a meeting of Unit Owners has been called to determine to provide no reserves or reserves less adequate than required, and such result is not attained or a quorum is not attained, the reserves, as included in the budget, shall go into effect. Reserve funds and any interest accruing thereon shall remain in the reserve account or accounts and shall be used only for authorized reserve expenditures, unless their use for other purposes is approved in advance by a vote of the majority of the voting interest voting in person or by limited proxy at a duly called meeting of the Association.

The adoption of a budget for the Condominium shall comply with the requirements hereinafter set forth:

- (i) Notice of Meeting. A copy of the proposed budget of Common Expenses shall be mailed to each Unit Owner not less than fourteen (14) days prior to the meeting of the Board of Directors at which the budget will be considered, together with a notice of that meeting indicating the time and place of such meeting. The meeting shall be open to the Unit Owners, and the Unit Owners shall have a reasonable right to participate with reference to all agenda items. The Board may adopt reasonable rules governing the frequency, duration and manner of Unit Owners statements.
- (ii) Special Membership Meeting. If a budget is adopted by the Board of Directors which requires Assessments against such Unit Owners in any fiscal or calendar year exceeding 115% of such Assessments for the preceding year, as hereinafter defined, and the Board of Directors receives within twenty-one (21) days after adoption of the annual budget a written request from at least 10% of the Unit Owners, for a special meeting of the Unit Owners, such a meeting shall be held within sixty (60) days after adoption of the annual budget. Each Unit Owner shall be given at least fourteen (14) days written notice of said meeting. At the special meeting, Unit Owners shall consider and adopt a budget. The adoption of said budget shall require a vote of Owners of not less than a majority of all the voting interests of Units (including Units owned by the Developer). If a meeting of the Unit Owners has been called as

aforesaid and a quorum is not obtained or a substitute budget has not been adopted by the Unit Owners, the budget adopted by the Board of Directors shall go into effect as scheduled.

- (iii) Determination of Budget Amount. In determining whether a budget requires Assessments against Unit Owners in any year exceeding 115% of Assessments for the preceding year, there shall be excluded in the computations any authorized provisions for reasonable reserves made by the Board of Directors in respect of repair or replacement of the Condominium Property or in respect of anticipated expenses of the Association which are not anticipated to be incurred on a regular or annual basis, and there shall be excluded further from such computation Assessments for improvements to the Condominium Property.
- (iv) Proviso. As long as the Developer is in control of the Board of Directors of the Association, the Board shall not impose Assessments for any year greater than 115% of the prior year's Assessments, as herein defined, without the approval of a majority of Unit Owners other than the Developer.

- (b) Adoption by Membership. In the event that the Board of Directors shall be unable to adopt a budget for a fiscal year in accordance with the requirements of paragraph 9.1 (a) above, the Board of Directors may call a special meeting of Unit Owners for the purpose of considering and adopting such budget, which meeting shall be called and held in the manner provided for such special meetings in said paragraph, or propose a budget in writing to the members, and if such budget is adopted by the members, upon ratification by a majority of the Board of Directors, it shall become the budget for such year.

- 9.2 Assessments. Assessments against Unit Owners for their share of the items of the budget shall be made for the applicable fiscal year annually at least twenty (20) days preceding the year for which the Assessments are made. Such Assessments shall be due in equal quarterly (or monthly) installments, payable in advance on the first day of each quarter (i.e., January, April, July and October) (or each month at the election of the Board) of the year for which the Assessments are made. If annual Assessments are not made as required, Assessments shall be presumed to have been made in the amount of the last prior Assessments, and quarterly (or monthly) installments on such Assessments shall be due upon each installment payment date until changed by amended Assessments by the Board of Directors, subject to the terms herein. In the event the annual Assessments prove to be insufficient, the budget and Assessments may be amended at any time by the Board of Directors, subject to the provisions of paragraph 9.1 hereof, if applicable. Unpaid Assessments for the remaining portion of the fiscal year for which amended Assessments are made shall be payable in as many equal installments as there are full quarters (or months) of the fiscal year left as of the date of such amended Assessments, each such quarterly (or monthly) installment

to be paid on the first day of the quarter (or month), commencing the first day of the next ensuing quarter (or month). If only a partial quarter (or month) remains, the amended Assessments shall be paid with the next regular installment in the following year, unless otherwise directed by the Board in its resolution.

- 9.3 **Assessments for Emergencies or Special Purposes.** Assessments for Common Expenses for emergencies or for other special purposes ("Special Assessments"), as determined by the Board of Directors, that cannot be paid from the annual Assessments for Common Expenses, shall be due only after ten (10) days' notice is given to the Unit Owners concerned, and shall be paid in such manner as the Board of Directors of the Association may require in the notice of such Assessments.
- 9.4 **Late Assessments.** Assessments not paid within ten (10) days from the date due may bear interest from the date when due until paid at the then highest rate allowed by law. Additionally, the failure to pay any assessment within ten (10) days from the date due shall entitle the Association to levy a late charge against the defaulting Unit Owner, in such amount as the Board may determine from time to time; provided, however, such late charge shall not exceed the maximum amount allowed under the Act (as amended from time to time).
- 9.5 **Depository.** The depository of the Association shall be those banks or savings and loan institutions, state or federal, located in Florida, as shall be designated from time to time by the Directors and in which the monies of the Association shall be deposited. Withdrawal of monies from those accounts shall be made only by checks signed by such person or persons as are authorized by the Directors. All sums collected by the Association from Assessments or contributions to working capital or otherwise shall be maintained separately in the Association's name. In addition, reserve funds shall be maintained separately from operating funds in separate accounts and shall not be commingled. No manager or business entity required to be licensed or registered under Florida Statutes, Section 468.432, and no agent, employee, Officer, or Director of the Association shall commingle Association funds with his, her or its own funds or another Association or entity's funds.
- 9.6 **Acceleration of Installments Upon Default.** As an additional right and remedy of the Association, if a Unit Owner shall be in default in the payment of an installment of his Assessments after thirty (30) days prior written notice to the applicable Unit Owner, the Board of Directors or its agent may accelerate the Assessments due for the remainder of the quarter, and thereafter, if a claim of lien has been filed, the Assessments shall be accelerated for the balance of the budget year. The unpaid balance of the Assessments for the balance of the accelerated period shall be due and payable on the date the claim of lien has been filed, but not less than five (5) days after delivery of the notice to the Unit Owner, or not less than ten (10) days after the mailing of such notice to him by certified mail, whichever shall first occur.

- 9.7 **Enforcement of Assessments.** In the event an Assessment is not paid within ten (10) days of the date same shall be due and payable, the Association, through the Board of Directors, may proceed to enforce and collect said Assessments from the delinquent Unit Owner in any manner provided for by the Condominium Act, the Declaration of Condominium and these By-Laws. Each Unit Owner shall be individually responsible for the payment of assessments against his Unit and for the payment of reasonable attorneys' fees and costs incurred by the Association in the collection of sums due and enforcement of any lien held by the Association.
- 9.8 **Fidelity Bonds.** Fidelity bonds shall be required by the Board of Directors for all persons handling or responsible for Association funds in such amount as shall be determined by a majority of the Board provided that such amount is not less than that required by the Act. The premiums on the amount of the bonds shall be paid by the Association as a Common Expense.
- 9.9 **Accounting Records and Reports.** The Association shall maintain accounting records within the State of Florida, according to accounting practices normally used by similar associations. The records shall be open to inspection by Unit Owners or their authorized representatives at reasonable times and written summaries of them shall be supplied at least annually. Such records shall also be open to inspection by holders, insurers, and guarantors of first mortgages that are secured by Units in the Condominium Property. The records shall include, but not be limited to, (a) a record of all receipts and expenditures, and (b) an account for each Unit designating the name and current mailing address of the Unit Owner, the amount of Assessments, the dates and amounts in which the Assessments come due, the amount paid upon the account and the dates so paid, and the balance due. Written summaries of the records described in clause (a) above, in the form and manner specified below, shall be supplied to each Unit Owner annually.

Within ninety (90) days after the end of a fiscal year, the Association shall prepare and complete, or cause to be prepared and completed by a third party, a financial report for the preceding fiscal year. Within twenty-one (21) days after the financial report is completed or received by the Association from the third party, the Association shall mail, or furnish by personal delivery, to each Unit Owner, a copy of the financial report, in accordance with the uniform accounting principles and standards adopted by the Division or, a notice that a copy of the financial report will be mailed or hand delivered to the Unit Owner, without charge, upon receipt of a written request from the Unit Owner. The report of cash receipts and disbursements shall disclose the amount of receipts by accounts and receipt classifications and shall show the amount of expenses by accounts and expense classifications, including, if applicable, but not limited to, the following:

- (a) Cost for security;
- (b) Professional and management fees and expenses;
- (c) Taxes;

- (d) Cost for recreation facilities;
- (e) Expenses for refuse collection and utility services;
- (f) Expense for lawn care;
- (g) Cost for building maintenance and repair;
- (h) Insurance costs;
- (i) Administrative and salary expenses; and
- (j) Reserves accumulated and expended for capital expenditures, deferred maintenance, and any other category for which the Association maintains reserves.

9.10 **Application of Payment.** All payments made by a Unit Owner shall be applied as provided in these By-Laws, the Declaration or as otherwise determined by the Board.

9.11 **Notice of Meetings.** Notice of any meeting where Assessments against Unit Owners are to be considered for any reason shall specifically contain a statement that Assessments will be considered and the nature of any such Assessments.

10. **Roster of Unit Owners.** Each Unit Owner shall file with the Association a copy of the deed and closing statement or other document showing his ownership. The Association shall maintain such information. The Association may rely upon the accuracy of such information for all purposes until notified in writing of changes therein as provided above. Only Unit Owners of record on the date notice of any meeting requiring their vote is given shall be entitled to notice of and to vote at such meeting, unless prior to such meeting other Owners shall produce adequate evidence, as provided above, of their interest and shall waive in writing notice of such meeting.

11. **Parliamentary Rules.** Roberts' Rules of Order (latest edition) shall govern the conduct of the Association meetings when not in conflict with the Declaration, the Act, the Articles or these By-Laws.

12. **Amendments.** Except as in the Declaration provided otherwise, these By-Laws may be amended in the following manner:

12.1 **Notice.** Notice of the subject matter of a proposed amendment shall be included in the notice of a meeting at which a proposed amendment is to be considered.

12.2 **Adoption.** A resolution for the adoption of a proposed amendment may be proposed either by a majority of the Board of Directors or by not less than 1/3 of the members of the Association. Any proposed amendment to these By-Laws must be made by ballot or by limited proxy, delivered to the Secretary of the Association at or prior to the meeting. The approval must be:

- (a) by not less than a majority of the votes of those members of the Association who are present or represented at a meeting at which a quorum has been attained and by not less than 66-2/3% of the entire Board of Directors; or
- (b) after control of the Association has been turned over to Unit Owners other than the Developer, by not less than 66-2/3% of the votes of the members of the Association represented at a meeting at which a quorum has been attained; or
- (c) by not less than 100% of the entire Board of Directors.

12.3 **Proviso.** No amendment may be adopted which would eliminate, modify, prejudice, abridge or otherwise adversely affect any rights, benefits, privileges or priorities granted or reserved to the Developer or mortgagees of Units without the consent of said Developer and mortgagees in each instance. No amendment shall be made that is in conflict with the Act, the Articles or Declaration. No amendment to this Section shall be valid.

12.4 **Execution and Recording.** A copy of each amendment shall be attached to a certificate certifying that the amendment was duly adopted as an amendment of the By-Laws, which certificate shall be executed by the President or Vice President and attested by the Secretary or Assistant Secretary of the Association with the formalities of a deed, or by the Developer alone if the amendment has been adopted consistent with the provisions of the Declaration allowing such action by the Developer. The amendment shall be effective when the certificate and a copy of the amendment are recorded in the Public Records of the County.

13. **Rules and Regulations.** Attached hereto as Schedule "RR" and made a part hereof are initial rules and regulations concerning the use of portions of the Condominium and Association Property. The Board of Directors may, from time to time, modify, amend or add to such rules and regulations, except that subsequent to the date control of the Board is turned over by the Developer to Unit Owners other than the Developer, Owners of a majority of the Units may overrule the Board with respect to any such modifications, amendments or additions. Copies of such modified, amended or additional rules and regulations shall be furnished by the Board of Directors to each affected Unit Owner not less than ten (10) days prior to the effective date thereof. At no time may any rule or regulation be adopted which would prejudice the rights reserved to the Developer.

14. **Construction.** Wherever the context so permits or requires, the singular shall include the plural, the plural shall include the singular, and use of any gender shall be deemed to include all genders.

15. **Captions.** The captions herein are inserted only as a matter of convenience and for reference, and in no way define or limit the scope of these By-Laws or the intent of any provision hereof.

16. **Official Records.** From the inception of the Association, the Association shall maintain a copy of each of the following, where applicable, which shall constitute the official records of the Association:
- (a) The plans, permits, warranties, and other items provided by the Developer pursuant to Section 718.301(4) of the Act.
 - (b) A photocopy of the recorded Declaration of Condominium and all amendments thereto.
 - (c) A photocopy of the recorded By-Laws of the Association and all amendments thereto.
 - (d) A certified copy of the Articles of Incorporation of the Association, or other documents creating the Association, and all amendments thereto.
 - (e) A copy of the current Rules and Regulations of the Association.
 - (f) A book or books containing the minutes of all meetings of the Association, of the Board of Directors, and of the Unit Owners, which minutes shall be retained for a period of not less than 7 years.
 - (g) A current roster of all Unit Owners, their mailing addresses, Unit identifications, voting certifications, and if known, telephone numbers. Additionally, the Association may require a copy of the deed or other instrument showing each Unit's ownership, together with a copy of any mortgage on the Unit and any satisfaction of that mortgage.
 - (h) All current insurance policies of the Association and the Condominium.
 - (i) A current copy of any management agreement, lease, or other contract to which the Association is a party or under which the Association or the Unit Owners have an obligation or responsibility.
 - (j) Bills of sale or transfer for all property owned by the Association.
 - (k) Accounting records for the Association and the accounting records for the Condominium, according to good accounting practices. All accounting records shall be maintained for a period of not less than 7 years. The accounting records shall include, but not be limited to:
 - (i) Accurate, itemized, and detailed records for all receipts and expenditures.
 - (ii) A current account and a monthly, bi-monthly or quarterly statement of the account for each Unit designating the name of the Unit Owner, the due date and amount of each Assessment, the amount paid upon the account, and the balance due.

- (iii) All audits, reviews, accounting statements, and financial reports of the Association or Condominium.
- (l) All contracts for work to be performed. Bids for work to be performed shall also be considered official records and shall be maintained for a period of one (1) year.
- (m) Ballots, sign-in sheets, voting proxies and all other paper relating to voting by Unit Owners and elections, which shall be maintained for a period of one (1) year from the date of the election, vote or meeting to which the document relates.
- (n) All rental records when the Association is acting as agent for the rental of Units.
- (o) A copy of the current question and answer sheet as described in Section 718.504 of the Act.
- (p) All other records of the Association not specifically included in the foregoing which are related to the operation of the Association.

The official records of the Association shall be maintained in the County or at such other place as may be permitted by the Act (as amended from time to time).

The official records of the Association shall be open to inspection by any Association member or the authorized representative of such member or by holders, insurers, and guarantors of first mortgages that are secured by Units in the Condominium Property at all reasonable times in accordance with reasonable rules regarding the frequency, time, location, notice and manner of records inspections and copying adopted by the Association. Inspection may only take place at the building in which the records are located and said records shall not be removed from said location. The right to inspect the records includes the right to make or obtain copies, at the reasonable expense, if any, of the Association member.

17. **Indemnification.** Every Officer and Director of the Association shall be indemnified by the Association against all expenses and liabilities, including reasonable attorneys' fees incurred by or imposed upon him in connection with any proceedings to which he may be a party, or in which he may become involved by reason of being or having been an Officer or Director of the Association, whether or not an Officer or Director at the time the expenses are incurred. The Officer or Director shall not be indemnified if adjudged guilty of gross negligence or willful misconduct, or if he shall have breached his fiduciary duty to the members of the Association. The Association shall not be liable, however, for payment of a voluntary settlement unless it is first approved in writing by the Board of Directors. The foregoing right of indemnification shall be in addition to, and not exclusive of, all other rights to which the Director or Officer may be entitled.

18. **Priorities in Case of Conflict.** In the event of conflict between or among the provisions of any of the following, the order of priority shall be, from highest priority to lowest:

- (a) The Act, as it existed on the date of recording of the Declaration;
- (b) The Declaration;
- (c) The Articles;
- (d) These By-Laws; and
- (e) The Rules and Regulations of the Association.

The foregoing was adopted as the By-Laws of MIRABELLA 1 CONDOMINIUM ASSOCIATION, INC. a corporation not for profit under the laws of the State of Florida, on the 7th day of November 2005.

MIRABELLA 1 CONDOMINIUM ASSOCIATION, INC., a Florida not for profit corporation

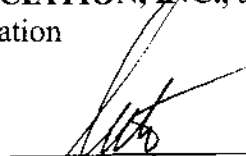
By: 
Name: Anthony C. Martin
Title: President

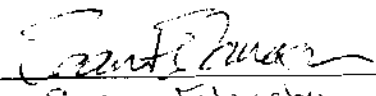
Attest: 
Name: Sean Flanagan
Its: Secretary

SCHEDULE "RR"

Rules and Regulations

SCHEDULE "RR"

Rules and Regulations

**SCHEDULE "RR"
TO
BY-LAWS**

**RULES AND REGULATIONS
FOR
MIRABELLA, A CONDOMINIUM**

(ALL REFERENCES HEREIN TO CAPITALIZED TERMS WHICH ARE NOT DEFINED IN THESE RULES AND REGULATIONS SHALL HAVE THE MEANINGS ASCRIBED THERETO IN THE DECLARATION OF CONDOMINIUM FOR MIRABELLA, A CONDOMINIUM ("DECLARATION"), THE ARTICLES OF INCORPORATION AND BY-LAWS FOR MIRABELLA I CONDOMINIUM ASSOCIATION, INC. ALL REFERENCES HEREIN TO OWNERS SHALL ALSO INCLUDE RESIDENTS.)

1. **OCCUPANCY.** Units shall be used only as residences and for no other purpose. Each Owner, tenant and occupant of a Unit should carefully review the Declaration for additional occupancy and use restrictions.

2. **USE.**

(a) No improper, offensive or unlawful use shall be made of any Unit, the Condominium Property, or of the Common Elements or any part thereof. All laws, zoning ordinances and regulations of all governmental authorities having jurisdiction thereof shall be observed.

(b) No Unit Owner shall permit or suffer anything to be done or kept in his Unit which will increase the rate of insurance on the Condominium Property, or which will obstruct or interfere with the rights of other Unit Owners or annoy them by unreasonable noises, smells or otherwise, nor shall any Unit Owner commit or permit any nuisance, immoral or illegal act in or about the Condominium Property.

(c) In order to preserve the residential character of the Condominium, no business, trade or profession of any type whatsoever shall be conducted from within any Unit in the Condominium (other than Units occupied by the Developer) without the prior written consent of the Association. The Association shall possess additional authority to promulgate rules and regulations governing the manner, method and to what degree additional uses other than noted in this document may be permitted, and further, the Association shall have the power to revoke the granting of such additional permitted uses, when in the Association's sole discretion, the use in question has become excessive and/or violates the residential character of the Condominium.

(d) The use of all Common Elements shall, at all times, be governed by these Rules and Regulations, as they may be amended from time to time by the Association, and by such other rules and regulations as may be posted, from time to time, in and about such Common Elements by the Association.

(e) Common Elements, Residential Limited Common Elements and Limited Common Elements shall only be used for the purposes intended, and shall not be used for the hanging of garments or other objects or for the cleaning of rugs or other items. Common Elements and Limited Common Elements shall not be obstructed, littered, defaced, or misused in any manner.

(f) All recreational facility rules and regulations, as posted on the Condominium Property, shall be strictly observed.

3. **PETS.** Not more than two (2) domestic pets (limited to either dogs, cats or other common household pets) may be kept in a Unit. No Unit Owner shall allow its pet(s) to commit any nuisance or to interfere with the rights of other Unit Owners or to unreasonably annoy other Unit Owners or make improper use of the Condominium Property or the Common Elements. No Pit Bulls or other similar breeds shall be permitted at any time. Pet waste must be removed by Owners immediately. Pets may only be walked in areas designated by the Association. The Owner of any pet agrees to indemnify the Association and hold it harmless for any loss or liability arising out of the ownership of such pet.

4. **APPARATUS AND ALTERATIONS.**

(a) No clothesline or similar device shall be allowed on any portion of the Condominium Property.

(b) A residential Unit Owner shall not cause anything to be affixed or attached to, hung, displayed or placed on the exterior walls, doors, balconies, terraces, storm shutters, or windows of a Building, Common Elements, Condominium Property, or a Unit, except with the prior written consent of the Association, and further, if and when approved, subject to the conditions designated and adopted by the Association. All screening, window and exterior glass door coverings and drape linings shall only be in the colors specified by the Association. Anything to the contrary notwithstanding, any Unit Owner may display one portable, removable United States flag in a respectful way and, on Armed Forces Day, Memorial Day, Flag Day, Independence Day, and Veterans Day, may display in a respectful way portable, removable official flags, not larger than 4½ feet by 6 feet, that represent the United States Army, Navy, Air Force, Marine Corps, or Coast Guard.

(c) Installation of satellite dishes by Unit Owners shall be restricted in accordance with the following: (i) installation shall be limited solely to the Unit or any Limited Commons Elements appurtenant thereto, and may not be on or encroach onto the Common Elements; (ii) the dish may be no greater than one meter in diameter; and (iii) to the extent that same may be accomplished without (a) impairing reception of an acceptable quality signal, (b) unreasonably preventing or delaying installation, maintenance or use of an antenna, or (c) unreasonably increasing the cost of installing,

maintaining or using an antenna, the dish shall be placed in a location which minimizes its visibility from the Common Elements.

(d) Television, radios, musical instruments and other instrumentality of sound reproduction or amplification must be used at such times and at such levels as will provide a minimum disturbance to other Unit Owners. No radio or television installation or other electrical equipment shall be permitted in any Unit if it interferes with the television or radio reception of another Unit. Except as provided herein, no exterior antenna shall be permitted on the Condominium Property, provided that the Developer shall have the right (but not the obligation) to install and maintain community antennae, radio and television lines, security systems, and communications systems.

(e) All portions of the Common Elements must, at all times, be kept free of obstruction. No garbage cans, supplies, or other articles shall be placed in the pathway, halls, driveways, walkways or parking areas. All garbage shall be properly bagged and deposited in garbage disposal areas designated by the Association.

(f) No Unit Owner shall in anyway affix any "for sale" or "for rent" signs or any other kinds of signs, notices or advertisements to the exterior of his Unit or in any way allow any signs to be visible to the general public from within his Unit.

(g) No flammable, combustible or explosive fluids, chemicals or other substances shall be kept in any Unit or on the Common Elements.

(h) Curtains, draperies, and other window coverings (including their linings) which face on exterior windows or glass doors of Units shall be white or off-white in color unless otherwise specifically approved by the Association.

(i) Except for Developer, repair, construction, decorating or remodeling work will be performed on Mondays through Saturdays between the hours of 8:00 a.m. and 5:00 p.m., and no such work shall be performed on Sundays or legal holidays, except in case of emergency authorized by the Association and as necessary by the Developer, in the Developer's sole discretion.

(j) No articles other than patio-type furniture shall be placed on the balconies, lanais, patios or other Common Elements.

(k) No terrace shall be cleaned in such a manner as to cause water or debris to drain from said terraces to other terraces below.

(l) No bicycles, skateboards, scooters, or similar equipment shall be permitted in the lobby, pool or other recreational areas. Bicycles shall be stored only in areas designated by the Association.

5. **CHILDREN.** Children shall be the direct responsibility of their parents or legal guardians, including full supervision of children while within the Condominium Property and including full compliance by children with these Rules and Regulations and all other rules and regulations of the Association. Loud Noises will not be tolerated. All children under the age of

twelve (12) years of age must be accompanied by an responsible adult over the age of eighteen (18) years of age when entering and /or utilizing the recreational facilities.

6. **ASSOCIATION.**

(a) No Owner, tenant or occupant of a Unit shall direct, supervise or in any manner attempt to assert any control over any of the employees of the Association, nor shall he or she attempt to send any such employees on private business of such Unit Owner, tenant, or occupant; such employees are to be directed only by Officers of the Association or the management personnel engaged by the Association.

(b) The Association, through its Officers or any designated Agent, may maintain a pass key to each Unit for utilization for pest extermination services and/or only in the event of emergency, such as fire, leakage, etc. No Owner, tenant, or occupant of a Unit shall alter any lock or install a new lock in any door leading into the Unit of such Owner without the prior written consent of the Association. In the event such consent is given, the Unit Owner shall provide the Association's Officer or agent with an additional key for the use of the Association pursuant to its right of access to each Unit. Should an Owner fail to provide such a key, the Association shall have the right to forcibly enter for purposes provided herein and under the Declaration.

7. **PARKING.**

(a) Parking areas are solely for non-commercial automobiles with a current passenger registration. No vehicle which cannot operate on its own power shall be permitted to remain on the Condominium Property for more than twenty-four (24) hours. Speed limits shall be strictly observed.

(b) No commercial vehicles, campers, mobile homes, motor homes, house trailers or trailers of any other description, recreational vehicles, boats or boat trailers shall be permitted to be parked or to be stored at any place on the Condominium Property or in/or designated parking areas. This prohibition of parking shall not apply to temporary parking of trucks and commercial vehicles, such as for pick-up, delivery and other temporary commercial services, or to any of the Association's or Developer's vehicles, subject to the terms herein.

(c) No vehicle maintenance or repairs shall be performed on the Condominium Property, except for emergency repairs.

(d) No vehicle belonging to any Owner or to a member of the family of an Owner or guest, tenant or employee of an Owner shall be parked in such a manner as to impede or prevent access to another Owner's parking space.

(e) Except for guest parking spaces, each parking space is assigned as an appurtenance to a particular Unit. As such, each space may be used only by the Owner except when the Owner has given written permission (copy to the Association) for use by another Owner, lessee or occupant.

8. **PLUMBING.** Water closets and other plumbing shall not be used for any purposes other than those for which they are constructed. No sweepings, rubbish, rags or other foreign substances shall be stored in them. The cost of any damage resulting from misuse shall be borne by the person causing the damage and, in the case of guests, by the Unit Owner who invited the guest onto the Condominium Property.

9. **RESPONSIBILITY FOR DELIVERIES.** Unit Owners shall be liable for damages to the Condominium Property caused by receiving deliveries, or moving or removing furniture or other articles to or from their respective Units.

10. **SOLICITATION.** There shall be no solicitation by any person anywhere in or on the Condominium Property for any cause, charity or any other purpose whatsoever, unless specifically authorized by the Association.

11. **OPEN DOORS.** No occupant shall allow the front entrance to his or her Unit to remain open for any purpose other than immediate ingress and egress.

12. **FOOD AND BEVERAGES.** Food and beverages shall be consumed only within Units and in such other areas specifically designated for such use by the Association.

13. **ODORS.** No noxious or unusual odors shall be generated in such quantities that they permeate to other Units and become annoyances or become obnoxious to other Owners. Normal cooking odors, normally and reasonably generated from kitchens shall not be deemed violations of this regulation.

14. **COOKING DEVICES.** No fires, cooking devices, grills or other devices which emit smoke or dust shall be allowed or used upon any balcony or terrace. Such cooking devices may only be used in outdoor cooking areas designated by the Association.

15. **HURRICANE/STORM SHUTTERS.** All Owners, tenants and occupants of a Unit shall have all hurricane and storm shutters approved by the Association prior to the installation thereof. Each Unit Owner who plans to be absent during the hurricane season must prepare his Unit before departure by removing all furniture, potted plants and other removal objects from outside areas, by designating a responsible firm or individual to care for the Unit in the event of a hurricane threat and/or should the Unit suffer hurricane damage, and by furnishing the Board with the name of said firm or individual. Such firm or individual designated by the Owner shall be subject to the approval of the Association. Should such firm or individual not be designated or available, the Association is authorized to take whatever steps are necessary in its discretion to protect the Unit and the Condominium Property at the sole cost and expense of the Owner.

16. **EXTERIOR CHANGES.** No exterior changes to the Units, including changes to Limited Common Elements, shall be made by any Unit Owner without the prior written approval of the Board of Directors pursuant to the terms and provisions of the Declaration of Condominium.

17. **COMPLIANCE BY UNIT OWNERS.** All Owners, tenants, invitees, licensees, guests, family members, agents, employees and occupants of a Unit shall comply with these

Rules and Regulations, and any and all rules and regulations which may, from time to time, be adopted by the Association, and the provisions of the Declaration, Articles of Incorporation and By-Laws of the Association. Failure of any of the foregoing persons to comply with the terms of this paragraph may subject that person to the imposition of a fine (upon notice and hearing) and to possible legal remedies, including, but not limited to, suits for money damages, injunctive relief, or any combination thereof, as set forth in the Declaration, the Articles and By-Laws.

18. **COMPLIANCE BY DEVELOPER.** These Rules and Regulations shall not be applicable to the Developer, its designees, successors and assigns, or to Units owned by the Developer, except for those specific rules and regulations contained herein that pertain to Association approval of leases, restrictions on the presence of pets, restrictions on occupancy of Units based on age, and restrictions on the type of vehicles allowed to park on Condominium Property or Association Property; provided, however, the Developer and its designees shall have the right to be exempt from any such parking restriction if the vehicle is engaged in any activity relating to construction, maintenance, or marketing of Units. These Rules and Regulations do not purport to constitute all of the restrictions affecting the Condominium Property. Reference should be made to the Declaration, Articles of Incorporation and By-Laws of the Association, and any other documents governing the Condominium Property.

19. **RELIEF.** The Board of Directors shall have the power, but not the obligation, to grant relief to one or more Unit Owners under the particular circumstances involved from the provisions for specific restrictions contained in these Rules and Regulations upon written request therefor, and for good cause shown in the sole opinion of the Board.

20. **APPROVALS.** All approvals required or permitted hereunder from the Association shall be in writing.

MIRABELLA I CONDOMINIUM
ASSOCIATION, INC., a Florida not-for-profit
corporation

By: _____
Name: Anthony C. Martin
Its President

Attest: Sean Flanagan
Name: Sean Flanagan
Its Secretary

EXHIBIT "4"
PLOT PLAN, SURVEY, AND
GRAPHIC DESCRIPTION OF IMPROVEMENTS

Mirabella, a Condominium

CITY OF JACKSONVILLE, DUVAL COUNTY, FLORIDA

GENERAL NOTES

1. Condominium units, including direct access garages, are identified by number 06 and unit type B2.
2. Limited common elements are identified by designation (L.C.E.) and common elements are identified by designation (C.E.).
3. Interior room dimensions are from the architectural plans and are subject to normal construction variances and tolerances.
4. Ceiling and elevations upper story referred to herein are elevations of a horizontal plane projected across the condominium units, and are from the architectural plans and are subject to normal construction variances and tolerances; however, if applicable for units with vaulted ceilings, the space above this horizontal plane and below the underside of the unfinished surface of the vaulted ceiling is a part of the condominium unit.
5. The legal description of subject property as contained herein is from the title commitment issued by Chicago Land Title Insurance Company, Commitment No. 150502064, revised June 27, 2005.
6. There are 188 direct access parking garages, 478 outside regular parking spaces and 32 handicapped parking spaces on the property.
7. There are 60 attached storage compartments on the property.

INDEX OF SHEETS

- | | |
|-------|---|
| 1 | Index, General Notes |
| 2 | Certifications |
| 3 | Legal Descriptions |
| 4 | Exceptions |
| 5 | Boundary Key Sheet, Vicinity Map & Surveyor's Notes |
| 6-B | Boundary Survey |
| 9-14 | Site Plan Key Sheet |
| 10-14 | Site Plan |
| 19-34 | Building Plans |
| 35-45 | Floor Plans |
| 48-52 | Elevations |
| 53 | Clubhouse Floor Plan |
| 54-55 | Unit Tabulations |



PREPARED BY:
ATLANTIC & GULF SURVEYING CO.
 LAND & ENGINEERING SURVEYS
 LICENSED BUSINESS # 8228
 6488 POWERS AVENUE
 JACKSONVILLE, FLORIDA 32286

Mirabella, a Condominium

CITY OF JACKSONVILLE, DUVAL COUNTY, FLORIDA

SURVEYOR'S CERTIFICATION

The undersigned hereby certifies to:
Omni-Tvill, LLC, a Florida limited liability company,
Tarragon South Development Corp., a Nevada corporation,
Broad and Cassel, Attorneys at Law and
Chicago Title Insurance Company

that (a) this plat of survey and the survey on which it was based were made in accordance with the "Minimum Technical Standards" as defined and set forth by the Florida Board of Professional Surveyors and Mappers in Chapter 61G17-6, Florida Administrative Code, pursuant to Section 472.027, Florida Statutes and in accordance with "Minimum Standard Detail Requirements for ALTA/ACSM Land Title Surveys" jointly established and adopted by the ALTA, ACSM and NSPS in 1989, and includes items 1, 2, 3, 4, 6, 7a, 8, 10, 11a, 13, 14, 15 and 16 of Table "A" thereof; and (b) this plat of survey and the property description set forth hereon ("Property") was prepared by me, a registered land surveyor in the State of Florida and was actually made upon the ground. In addition, the undersigned hereby certifies that (1) the information, courses and distances shown on its survey are correct, (2) the size, location and type of improvements are shown hereon (3) the Property is contiguous to Gate Parkway North, a dedicated public right of way, and access to the Property is provided by a separately granted easement for ingress and egress over Shish Mill Boulevard from Gate Parkway North, (4) there are no encroachments or utility lines of which I have been advised by title report or evident from visual observation of surface features affecting the Property other than as shown and depicted on this survey, (5) there are no encroachments of any improvements on this Property over any easements or encroachments, or onto adjoining property except as shown hereon, (6) there are no encroachments of any improvements on adjoining property onto the Property except as shown hereon, (7) recorded easements and other survey matters of record as noted in the Chicago Title Insurance Company's Commitment for Title Insurance No. 150502064, effective date April 11, 2005, (revised 05/27/05) have been correctly represented hereon; (8) the property is Zoned "AO" per ordinance No. 2005-639-E, (9) the Property constitutes one contiguous parcel without gaps or gaps, (10) the Property does not serve adjoining property for drainage or ingress or egress or any other purpose except as shown on the Survey, (11) no portion of the Property lies within 150 feet of a coastal body of water, and (12) a portion of the Property is located within Flood Zone "AO", depth 2 feet, as reflected by Flood Insurance Rate Map Panel Community No. 120077, panel numbers 02236E and 02236E, dated August 15, 1989. The Flood Insurance Rate Map defines Flood Zone "AO" as being "an area of flood depths of 1 to 3 feet (usually sheet flow on sloping terrain); average depths determined for areas of alluvial fan flooding, velocities also determined".

FLOOD CERTIFICATION

A hereby certify that I have examined the Current Flood Hazard Rate maps and that the property described herein and referred to as Mirabella, a Condominium, lies within Flood Zone "X" & "AO" 2 ft., as shown on the Federal Emergency Management Agency Flood Insurance Rate Map, Community of Duval County, Community No. 120077 Map and Panel No. 120077 02365 E, dated August 15, 1989.

CERTIFICATION

A survey of the land which meets the minimum technical standards set forth by the Board of Professional Surveyors and Mappers, pursuant to statute 472.027, and a graphic description of the improvements in which units are located and a plot plan thereof that, together with the declaration, are in sufficient detail to identify the common elements and each unit and their relative locations and approximate dimensions.

This is to certify that, in accordance with the provisions of Section 718.104 (4) (e), Florida Statutes, that the construction of the improvements described is substantially complete so that the material, together with the provisions of the Declaration of Condominium of Mirabella, a Condominium, describing the condominium property is an accurate representation of the location and dimensions of the improvements, and further that the identification, location and dimensions of the common elements and of each unit can be determined from these materials.

PREPARED BY:

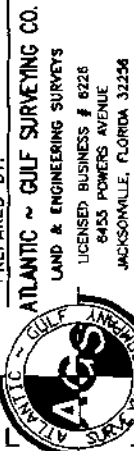

ATLANTIC & GULF SURVEYING CO.
LAND & ENGINEERING SURVEYS
LICENSED BUSINESS # 6226
8455 POWERS AVENUE
JACKSONVILLE, FLORIDA 32256

Signed this 10th day of Nov, A.D., 2005

Charles P. Delcambre

Charles P. Delcambre
Atlantic-Gulf Surveying Company, Inc.
Registered Land Surveyor No. 5100
State of Florida

EXHIBIT: SHEET: 2

Mirabella, a Condominium
CITY OF JACKSONVILLE, DUVAL COUNTY, FLORIDA

LEGAL DESCRIPTION

A PORTION OF SECTION 7, TOWNSHIP 3 SOUTH, RANGE 28 EAST, JACKSONVILLE, DUVAL COUNTY, FLORIDA,

A portion of Section 7, Township 3 South, Range 28 East, Jacksonville, Duval County, Florida, being more particularly described as follows:

For a Point of Reference, commence at the intersection of the West line of said Section 7, with the Northerly right of way line of Gate Parkway North (a 120 foot right of way as now established, by Plat Book 47, Pages 59 through 59 I of the current Public Records of said county); run thence South 80°22'08" East, along said Northerly right of way line, a distance of 571.88 feet to a point on a curve, also being the Point of Beginning. From the Point of Beginning (thus described, run thence Northwesterly along the arc of a curve concave Northwesterly with a radius of 50.00 feet, an arc distance of 96.00 feet to the point of tangency of said curve, said arc being subtended by a chord bearing and distance of North 25°21'51" West, 81.92 feet; run thence North 29°38'27" East, a distance of 596.13 feet; run thence North 60°12'34" East, a distance of 1603.79 feet; run thence South 20°04'24" East, a distance of 361.64 feet to a point of curvilinear; run thence Southeasterly along the arc of a curve concave Northeastly with a radius of 100.00 feet, an arc distance of 162.73 feet to a point on a solid curve, said arc being subtended by a chord bearing and distance of South 74°41'26" East, 143.36 feet; run thence South 27°14'16" East, a distance of 106.10 feet to the Northerly line of those lands described in Official Records Volume 8207, page 760; run thence Southwesterly along said Northerly line as follows: First course, run thence South 39°04'48" West, a distance of 198.14 feet; Second course, run thence South 71°21'25" West, a distance of 104.48 feet; Third course, run thence South 60°40'47" West, a distance of 108.53 feet; Fourth course, run thence South 60°14'12" West, a distance of 429.97 feet; Fifth course, run thence South 85°41'32" West, a distance of 88.59 feet; Sixth course, run thence South 73°30'14" West, a distance of 215.76 feet; Seventh course, South 62°37'53" West, a distance of 113.62 feet; Eighth course, South 53°14'43" West, a distance of 60.07 feet; Ninth course, run thence South 56°44'36" West, a distance of 153.23 feet; Tenth course, North 86°01'31" West, a distance of 50.34 feet; Eleventh course, run thence South 52°48'03" West, a distance of 200.26 feet; Twelfth course, South 46°07'57" West, a distance of 71.13 feet; Thirteenth course, South 12°48'27" West, a distance of 193.92 feet to a point on a curve, said point also lying on said Northerly right of way line of Gate Parkway North; run thence Northwesterly along said Northerly line, as follows: First course, along the arc of a curve concave Southwesterly with a radius of 1492.40 feet, an arc distance of 339.82 feet to the point of tangency of said curve, said arc being subtended by a chord bearing and distance of North 73°50'45" West, 319.03 feet; Second course, run thence North 80°22'08" West, a distance of 116.63 feet to the Point of Beginning.

TOGETHER WITH:

a. DRAINAGE EASEMENT AGREEMENT described in Official Records Book 9892, Page 1905, and drainage easements reserved in Paragraph 2 of Exhibit C of the Special Warranty Deed recorded in Official Records Book 8196, Page 942, all as assigned in Special Warranty Deed recorded in Official Records Book 8892, Page 1946, all [of] the Public Records of Duval County, Florida.

b. EASEMENT RIGHTS created by Declaration recorded in Official Records Book 8207, Page 785, as amended by instrument recorded in Official Records Book 9769, Page 851, both [of] the Public Records of Duval County, Florida.

c. GRANT OF EASEMENT recorded in Official Records Book 9995, Page 1633, as partially terminated by dedication to the EA as set forth on the Plat of Old Mill Branch Unit One, as recorded in Plat Book 54, Pages 29, 29A, and 29B, all of the Public Records of Duval County, Florida.

Mirabella, a Condominium

CITY OF JACKSONVILLE, DUVAL COUNTY, FLORIDA

EXCEPTIONS

CHICAGO TITLE INSURANCE COMPANY SCHEDULE "B" - SECTION 2:

The following items listed are those matters included in the Chicago Title Insurance Company Schedule B, Section 2, Commitment No. 150502064, Policy No. (10-17-82), Effective Date April 11, 2005, that affect the subject property as shown herein.

1. - 4. Standard exceptions or defects or claims against title. No official records cited.
5. Declaration of Covenants and Restrictions recorded in Official Records Book 8188, Page 801, Public Records of Duval County, Florida. (This document provides for assessments, this document also provides for lien.) (Does NOT affect subject parcel--refers to property to Southwest)
6. Easement to the City of Jacksonville recorded in Official Records Book 7181, Page 631, as re-recorded in Official Records Book 7207, Page 874, of the Public Records of Duval County, Florida. (Affects subject property in that it affects the drainage easement which benefits the parcel (O.R. 8207, page 785 and O.R. 8188, page 842)).
7. Easement to Jacksonville Electric Authority recorded in Official Records Book 8622, Page 535, of the Public Records of Duval County, Florida, as shown on survey by Robert M. Angus Associates, Inc., dated May 3, 2001, as revised May 9, 2001 (the "Survey"). (Affects subject parcel)
8. Developer Agreement recorded in Official Records Book 8188, Page 1750, of the Public Records of Duval County, Florida. (This document is an agreement between the city of Jacksonville and heirs to the original owners of parcels affected by the agreement, spelling out the obligations and development procedures to be followed by all parties to the agreement. (Affects entire subject parcel[no assessments to show])
9. Terms and conditions of Drainage Easements reserved in paragraph 2 of exhibit C of the special warranty deed recorded in Official Records Book 8188, Page 842, Public Records of Duval County, Florida. (Does NOT affect subject parcel--refers to property to Southwest)
10. Drainage Easement recorded in Official Records Book 8770, Page 1103, Public Records of Duval County, Florida, as shown on the survey. (Affects subject parcel)
11. Easements granted in deed recorded in Official Records Book 8207, Page 760, as modified by Modification of Drainage Easement recorded in Official Records Book 10135, Page 1987, both of Public Records of Duval County, Florida. (Affects subject parcel)

12. Easement to JEA recorded in Official Records Book 8728, Page 1800, Public Records of Duval County, Florida, as shown on the survey. (Affects subject parcel)
13. Terms, provisions, conditions restrictions and obligations set forth in Declaration recorded in Official Records Book 8307, Page 785, as amended by instrument recorded in Official Records Book 8760, Page 851, Public Records of Duval County, Florida. (This document provides for use of Lake #8, assessments and liens, and also provides for off-site drainage easement at Southeast and of Lake #8) (Benefits entire subject parcel)
14. - 15. Intentionally deleted.
16. Subject to covenants, conditions and restrictions as set out in Special Warranty Deed recorded in Official Records Book 9882, Page 1946, of the Public Records of Duval County, Florida. (Affects subject parcel)
17. Easement parcels subject to covenants, conditions, restrictions and provisions for assessments contained in Grant of Easements as set out in Drainage Easement Agreement recorded in Official Records Book 9892, Page 1905, of the Public Records of Duval County, Florida. (Grants use of off-site drainage and Lake (No. 1) to benefit subject parcel)
18. - 23. Intentionally deleted.
24. JEA Blanket Easement recorded in Official Records Book 9891, Page 2296, of the Public Records of Duval County, Florida. (Grants JEA electric easement over entire parcel with conditions.) (Affects entire subject parcel, but can not be depicted hereon)
27. Grant of Easement recorded in Official Records Book 12007, Page 1800, of the Public Records of Duval County, Florida. (Grants MediaOne Greater Florida, Inc. an easement over entire parcel with conditions.) (Affects entire subject parcel, but can not be depicted hereon)
28. Matters as shown on plot of Old Mt. Branch Unit One, as recorded in Plat Book 54, Pages 29A, 29B, and 28B, all of the Public Records of Duval County, Florida. (as to Together With Easement "C" only) (Affects subject parcel)

BOUNDARY
SHEET 3 OF 4

Mirabella, a Condominium
CITY OF JACKSONVILLE, DUVAL COUNTY, FLORIDA

OLD HILL BRANCH, LUP
D.A.V. 9780, PAGE 879
(L) N601234°E 1803.79'
(F) N801248°E 1803.84'

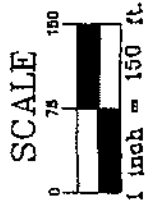
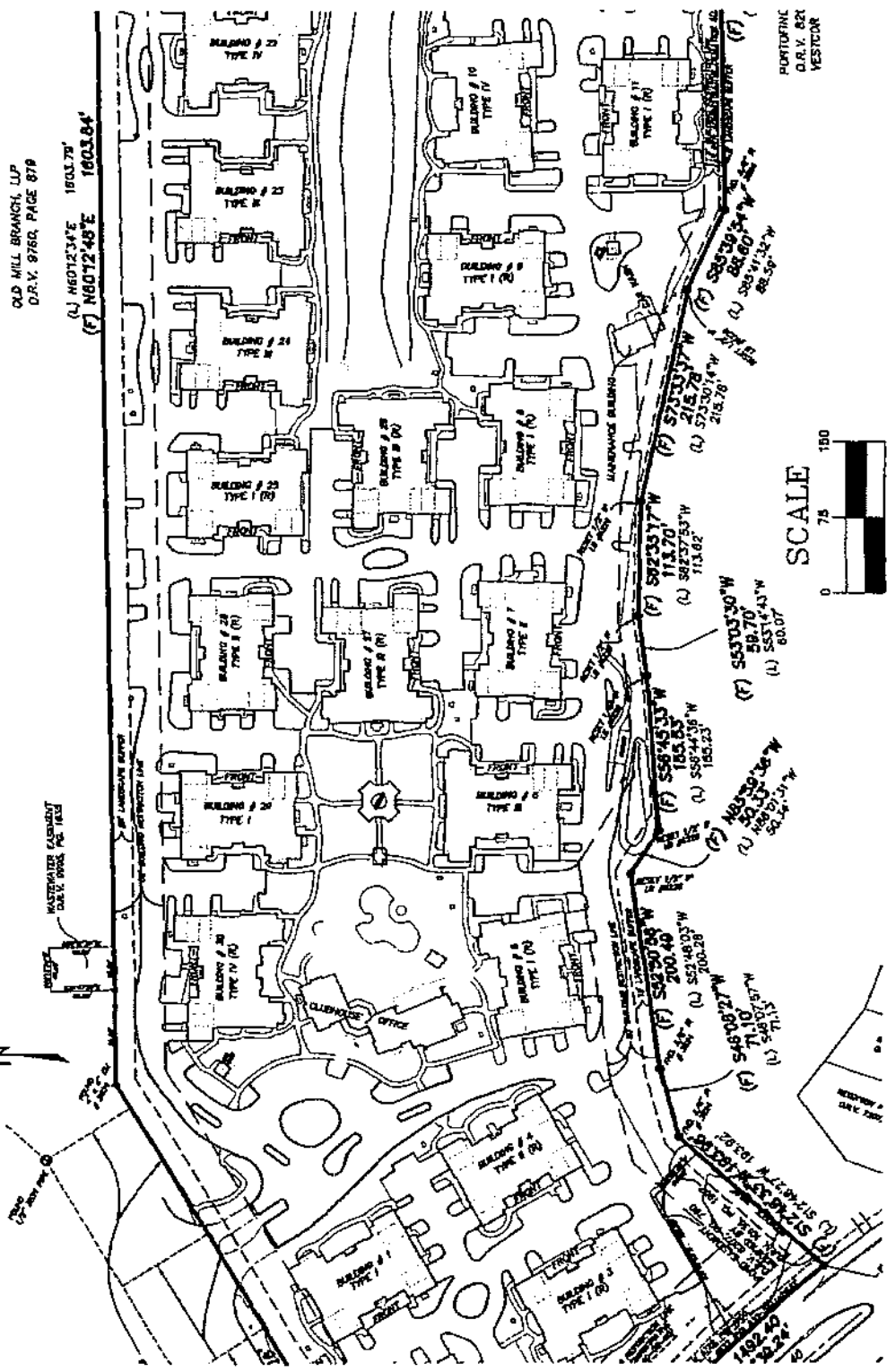





PORTOFINO
D.R.V. 827
WESTCO

EXHIBIT: SHEET: 7

PREPARED BY:
ATLANTIC & GULF SURVEYING CO.

SITEPLAN KEY SHEET
SHEET 1 OF 6

Mirabella, a Condominium
CITY OF JACKSONVILLE, DUVAL COUNTY, FLORIDA

- LEGEND**
-  DENOTES COMMON AREAS
 -  DENOTES REGULAR PARKING SPACES
 -  DENOTES HANDICAP PARKING SPACES
 -  DENOTES LIMITED COMMON ELEMENTS

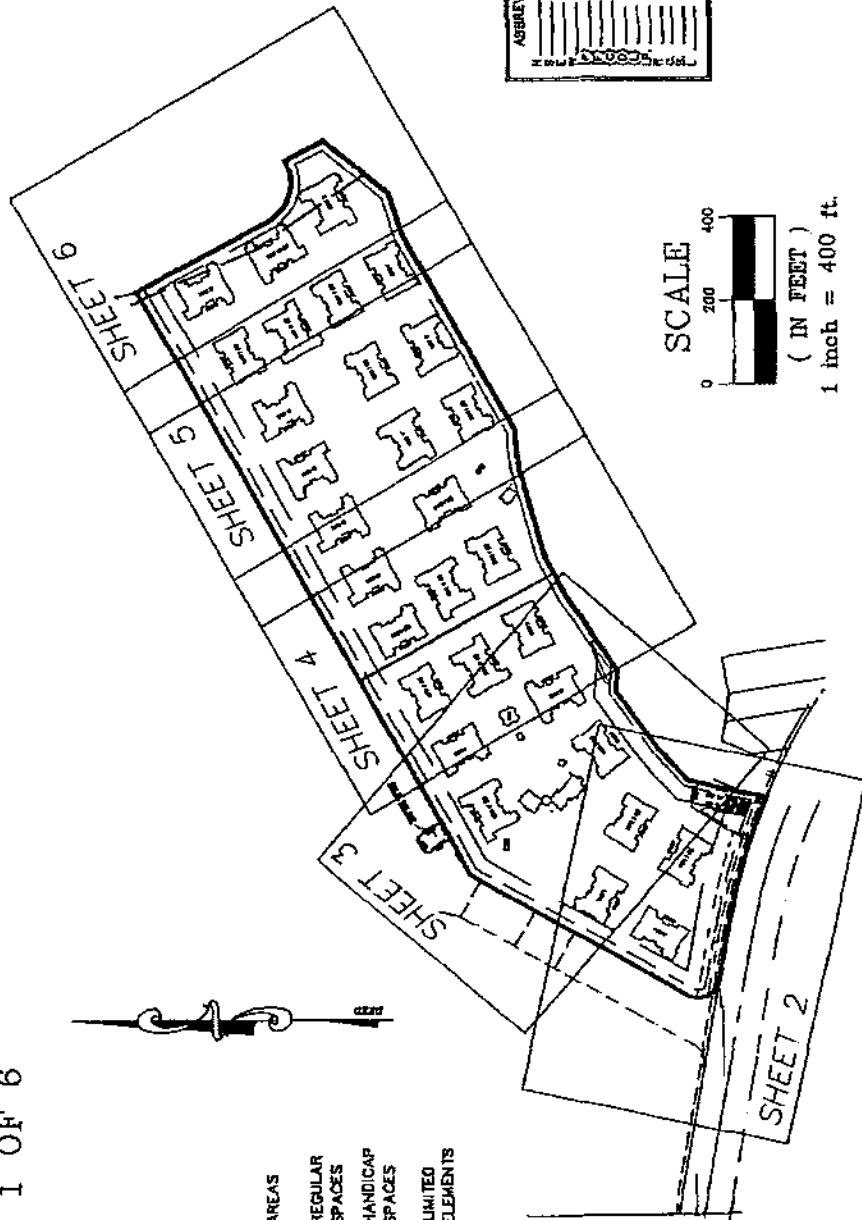

ABBREVIATIONS:

—	NORTH
—	EAST
—	WEST
—	PLAT
—	UNITS
—	CALCULATED
—	DEED
—	DEED RESERVATION
—	RADIUS
—	CHORD
—	ARC LENGTH

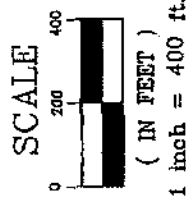

PREPARED BY:



ATLANTIC GULF SURVEYING CO.
LAND & ENGINEERING SURVEYS
LICENSED BUSINESS # 8226
8405 POWERS AVENUE
JACKSONVILLE, FLORIDA 32208

Mirabella, a Condominium
CITY OF JACKSONVILLE, DUVAL COUNTY, FLORIDA

SITE PLAN
SHEET 2 OF 6

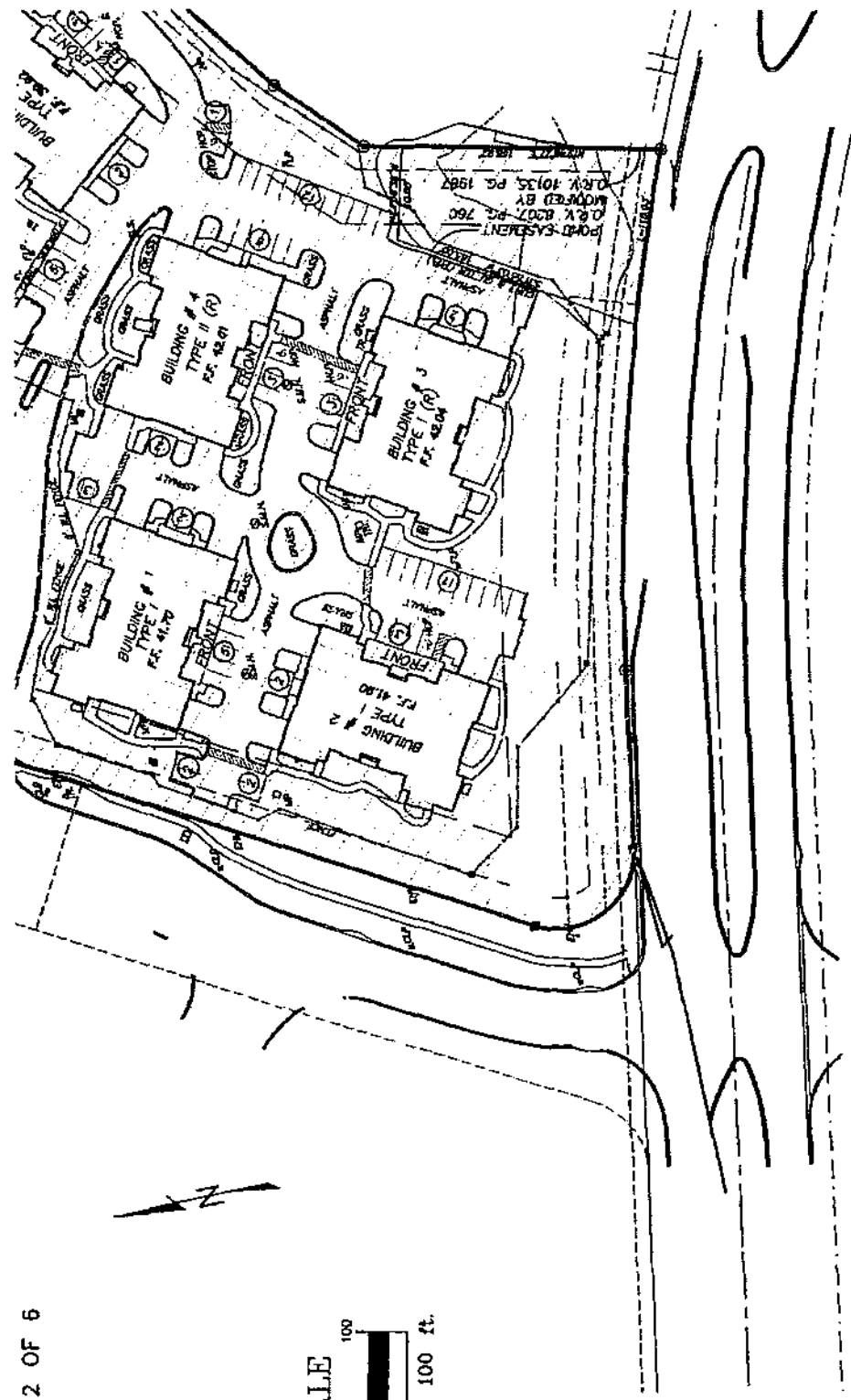

SCALE

 1 inch = 100 ft.

PREPARED BY:
ATLANTIC ~ GULF SURVEYING CO.

EXHIBIT: SHEET: 10

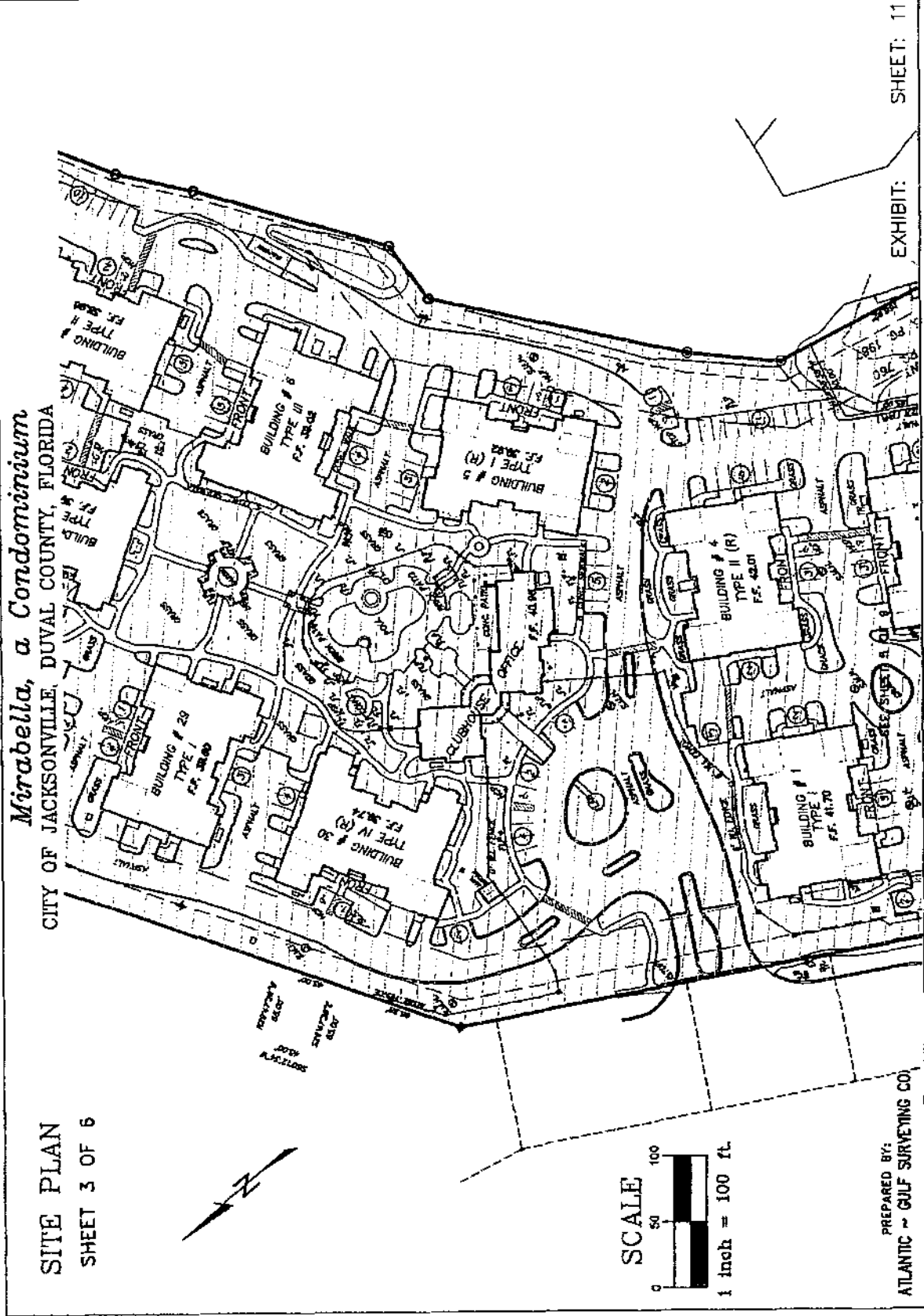

Mirabella, a Condominium
CITY OF JACKSONVILLE, DUVAL COUNTY, FLORIDA

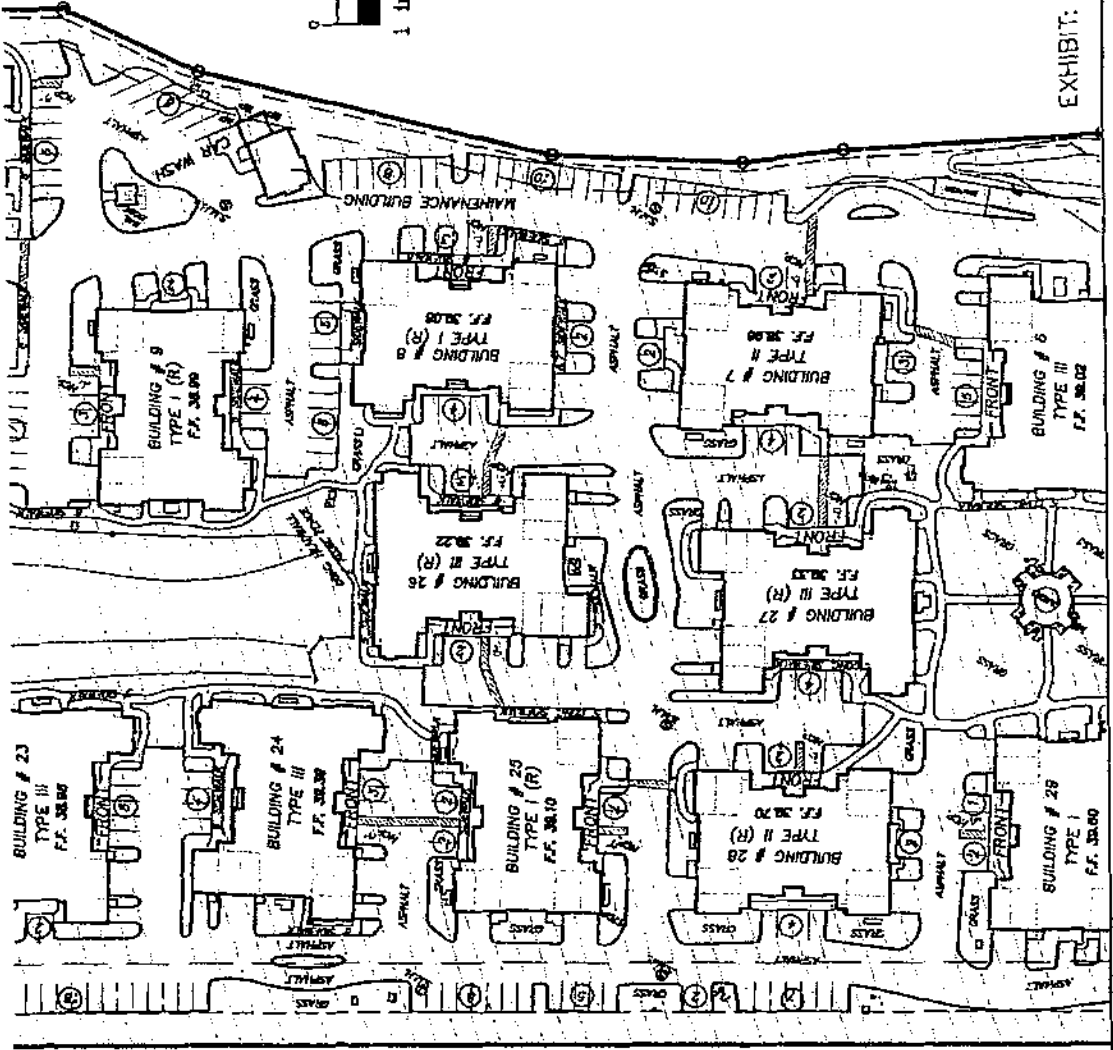

SITE PLAN
SHEET 4 OF 5

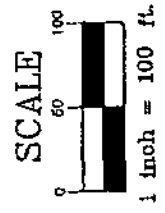
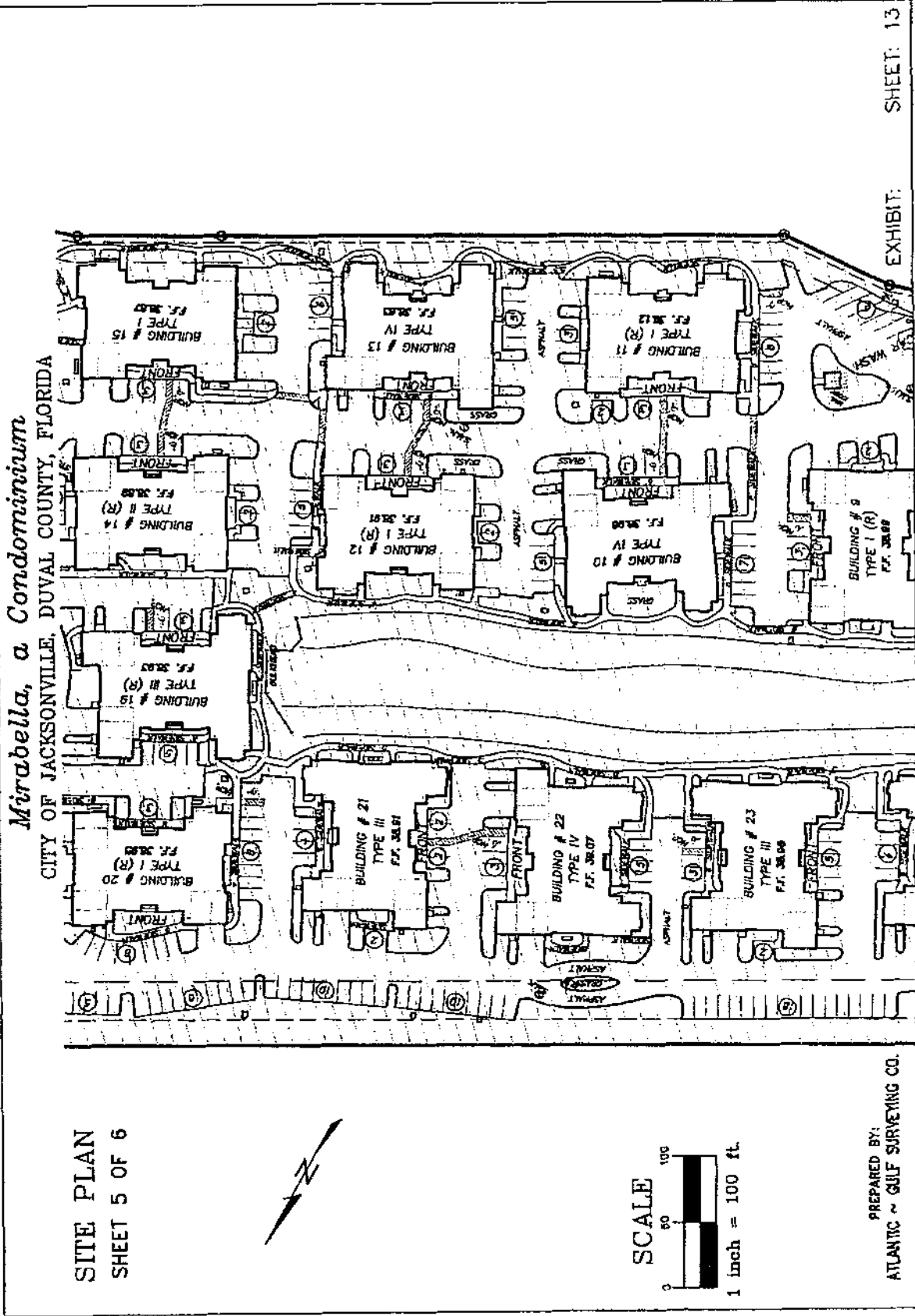

EXHIBIT: SHEET: 12

PREPARED BY:
ATLANTIC & GULF SURVEYING CO.



SITE PLAN
SHEET 5 OF 6



PREPARED BY:
ATLANTIC ~ GULF SURVEYING CO.

EXHIBIT: SHEET: 13

Mirabella, a Condominium
CITY OF JACKSONVILLE, DUVAL COUNTY, FLORIDA

SITE PLAN
SHEET 6 OF 6

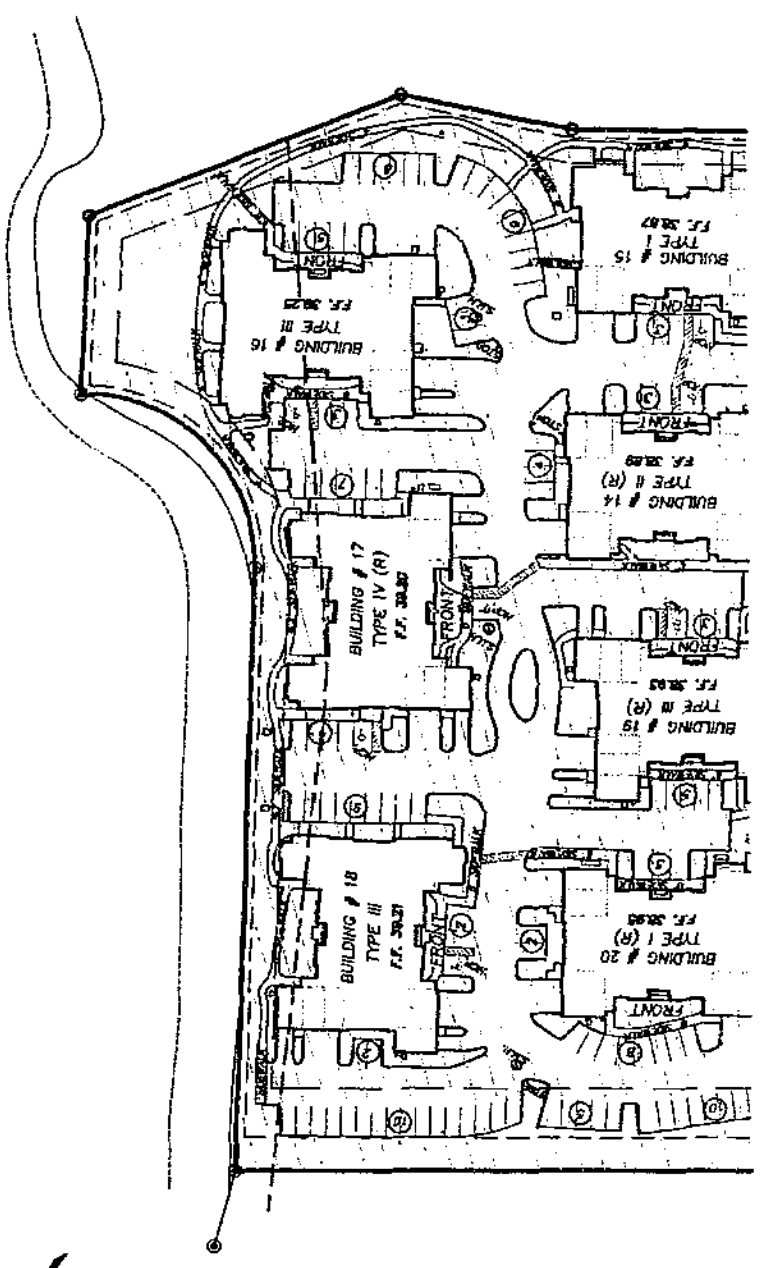

PREPARED BY:
ATLANTIC ~ GULF SURVEYING CO.

EXHIBIT: SHEET: 14

Mirabella, a Condominium
CITY OF JACKSONVILLE, DUVAL COUNTY, FLORIDA

BUILDING PLAN
TYPE I - 1ST FLOOR
BUILDINGS 1, 2, 15 & 29

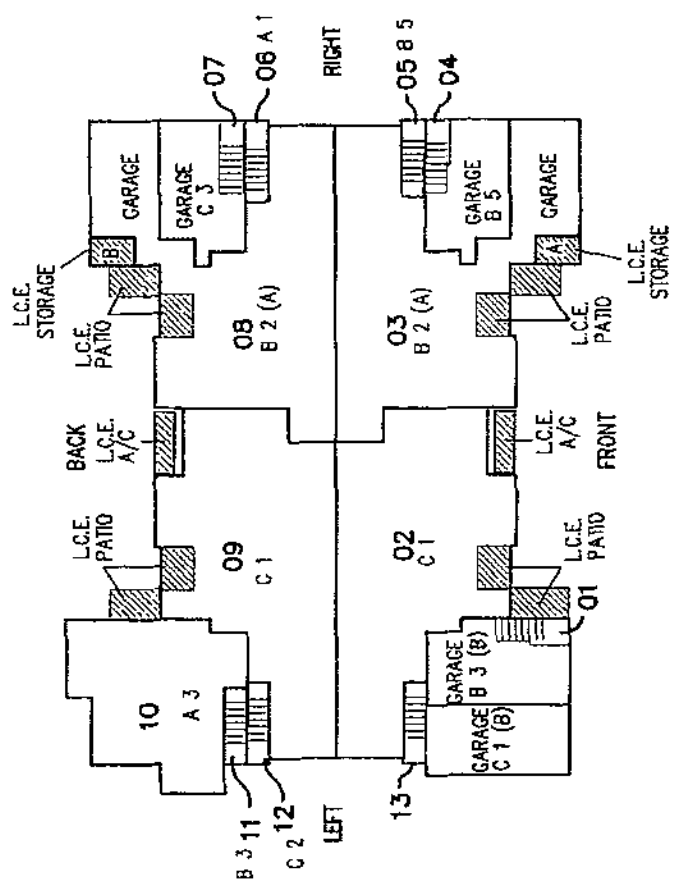

PREPARED BY:
ATLANTIC ~ GULF SURVEYING CO.
 LAND & ENGINEERING SURVEYS
 LICENSED BUSINESS # 02214
 6486 POWERS AVENUE
 JACKSONVILLE, FLORIDA 32206

(L.C.E.) = LIMITED COMMON ELEMENT
 (C.E.) = COMMON ELEMENT

SCALE
 1 inch = 30 ft.

EXHIBIT: SHEET: 15

Mirabella, a Condominium
CITY OF JACKSONVILLE, DUVAL COUNTY, FLORIDA

BUILDING PLAN
TYPE I - 2ND FLOOR
BUILDINGS 1, 2, 15 & 29

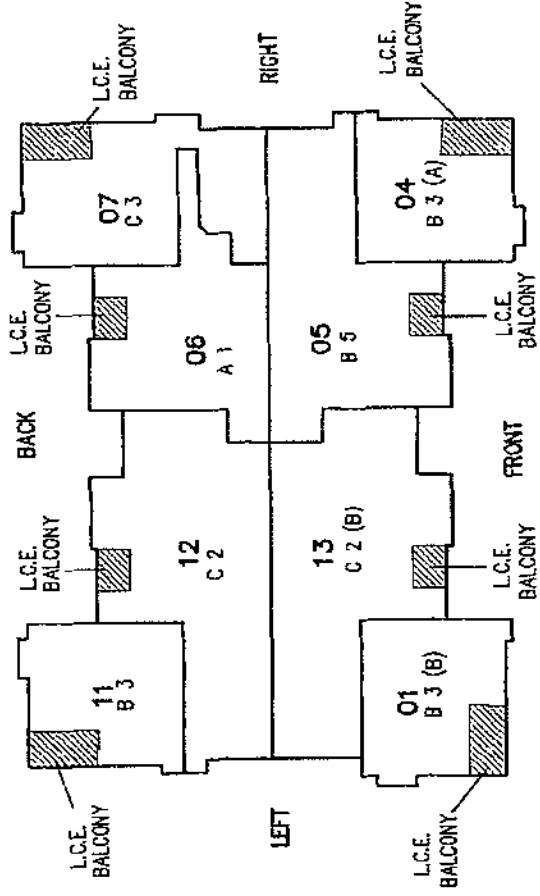

PREPARED BY:
ATLANTIC ~ GULF SURVEYING CO.
 LAND & ENGINEERING SURVEYS
 LICENSED BUSINESS # 0226
 6453 POWERS AVENUE
 JACKSONVILLE, FLORIDA 32266

(L.C.E.) = LIMITED COMMON ELEMENT
 (C.E.) = COMMON ELEMENT

SCALE
 1 inch = 30 ft.

EXHIBIT: SHEET: 16

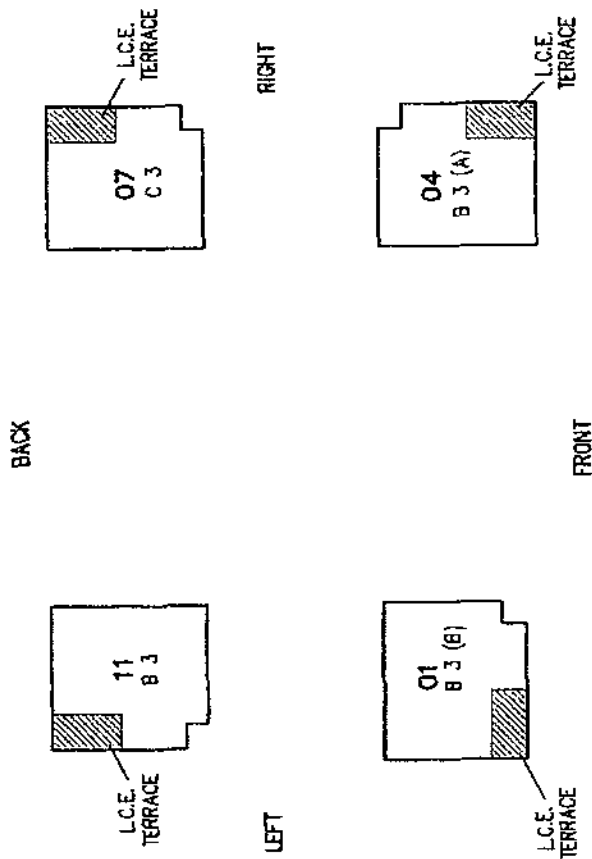

Mirabella, a Condominium
CITY OF JACKSONVILLE, DUVAL COUNTY, FLORIDA

BUILDING PLAN
TYPE I - 3RD FLOOR
BUILDINGS 1, 2, 15 & 29



PREPARED BY:

ATLANTIC GULF SURVEYING CO.
LAND & ENGINEERING SURVEYS
LICENSED BUSINESS # 9226
6456 POWERS AVENUE
JACKSONVILLE, FLORIDA 32266

 (L.C.E.) = LIMITED COMMON ELEMENT
 (C.E.) = COMMON ELEMENT

SCALE
1 inch = 30 ft.

EXHIBIT: SHEET: 17

Mirabella, a Condominium
CITY OF JACKSONVILLE, DUVAL COUNTY, FLORIDA

BUILDING PLAN
TYPE I REVERSED - 1ST FLOOR
BUILDINGS 3, 5, 8, 9, 11,
12, 20 & 25

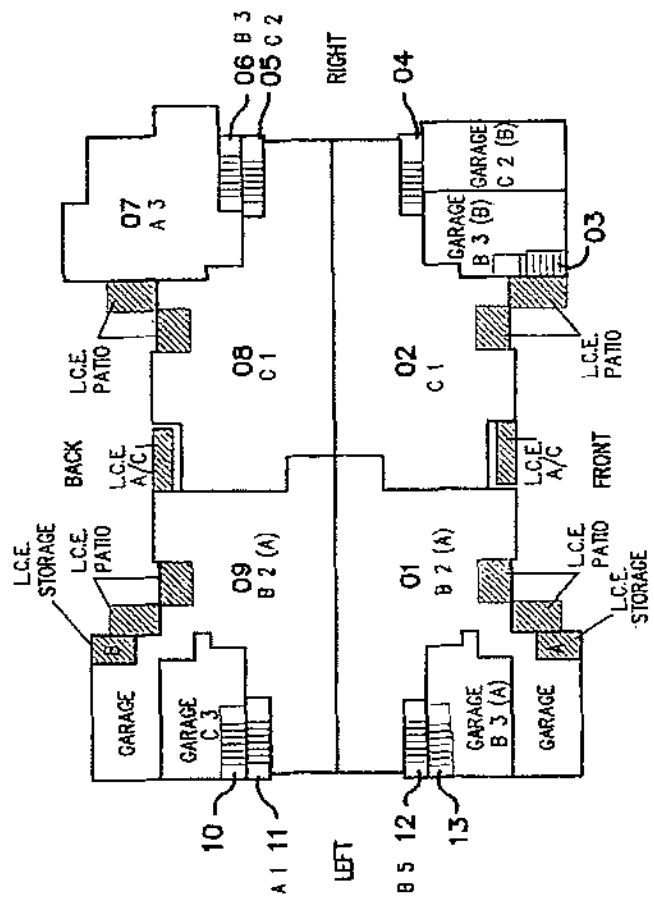

PREPARED BY:
ATLANTIC GULF SURVEYING CO.
 LAND & ENGINEERING SURVEYS
 LICENSED BUSINESS # 8226
 6455 POWERS AVENUE
 JACKSONVILLE, FLORIDA 32236

(L.C.E.) = LIMITED COMMON ELEMENT
(C.E.) = COMMON ELEMENT

SCALE
1 inch = 30 ft.

EXHIBIT: SHEET: 18

Mirabella, a Condominium
CITY OF JACKSONVILLE, DUVAL COUNTY, FLORIDA

BUILDING PLAN
TYPE I REVERSED - 2ND FLOOR
BUILDINGS 3, 5, 8, 9, 11,
12, 20 & 25

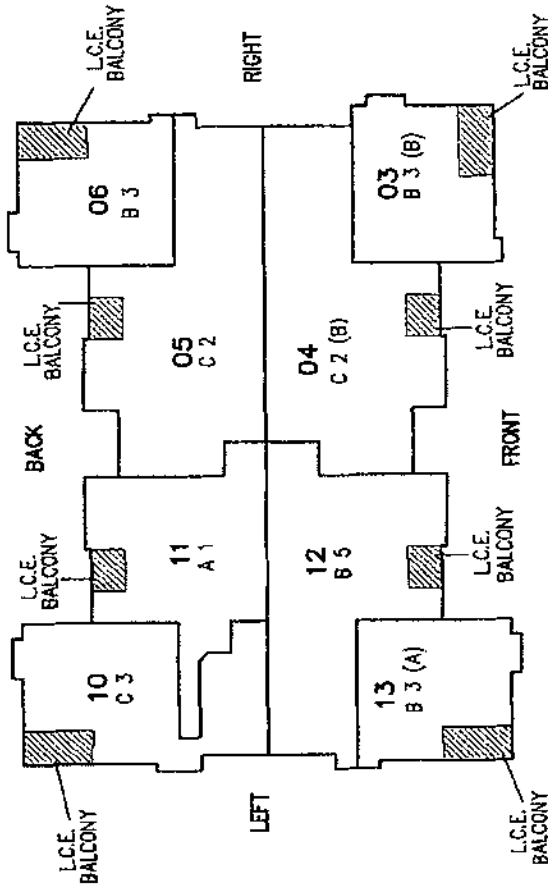

PREPARED BY:

ATLANTIC GULF SURVEYING CO.
 LAND & ENGINEERING SURVEYS
 LICENSED BUSINESS # 0228
 6459 POWERS AVENUE
 JACKSONVILLE, FLORIDA 32216

(L.C.E.) = LIMITED COMMON ELEMENT
 (C.E.) = COMMON ELEMENT

SCALE
 1 inch = 30 ft.

EXHIBIT:
 SHEET: 19

Mirabella, a Condominium
CITY OF JACKSONVILLE, DUVAL COUNTY, FLORIDA

BUILDING PLAN
TYPE I REVERSED - 3RD FLOOR
BUILDINGS 3, 5, 8, 9, 11,
12, 15 & 25

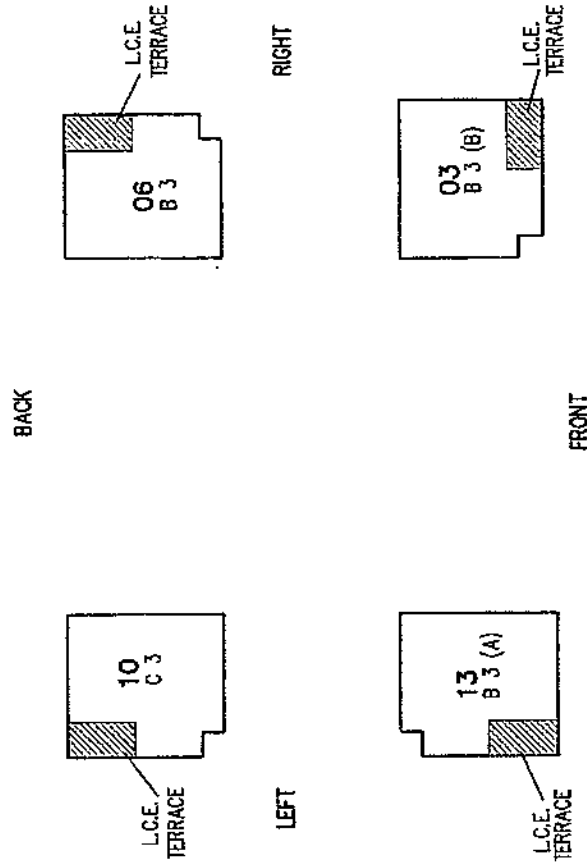

PREPARED BY:

ATLANTIC ~ GULF SURVEYING CO.
 LAND & ENGINEERING SURVEYS
 LICENSED BUSINESS # 0229
 9455 POWERS AVENUE
 JACKSONVILLE, FLORIDA 32236

(L.C.E.) = LIMITED COMMON ELEMENT
(C.E.) = COMMON ELEMENT

SCALE
1 inch = 30 ft.

EXHIBIT: SHEET: 20

Mirabella, a Condominium
CITY OF JACKSONVILLE, DUVAL COUNTY, FLORIDA

BUILDING PLAN
TYPE II - 1ST FLOOR
BUILDING 7

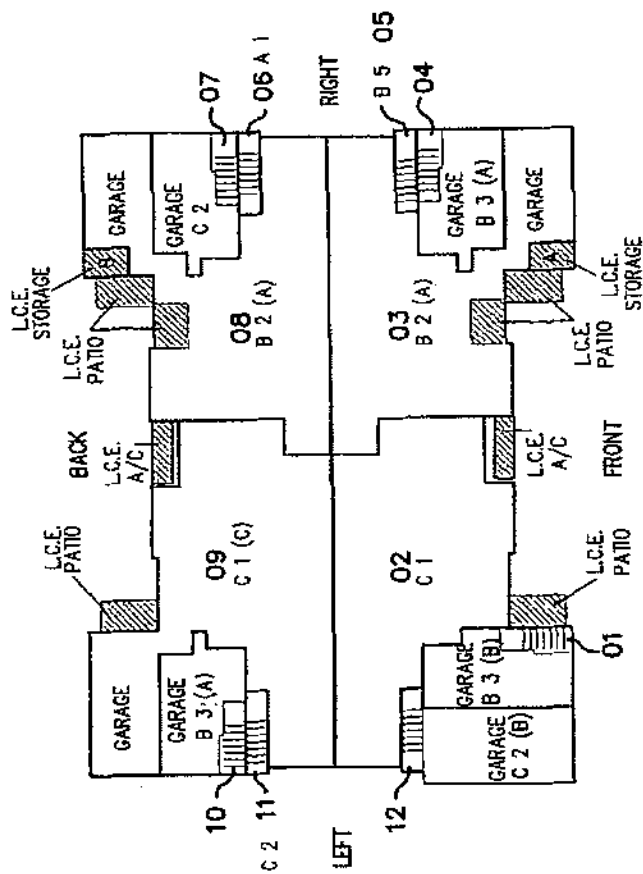

PREPARED BY:
ATLANTIC ~ GULF SURVEYING CO.
 LAND & ENGINEERING SURVEYS
 LICENSED BUSINESS # 0226
 8455 POWERS AVENUE
 JACKSONVILLE, FLORIDA 32286

SCALE
1 inch = 30 ft.

EXHIBIT: SHEET: 21

Mirabella, a Condominium
CITY OF JACKSONVILLE, DUVAL COUNTY, FLORIDA

BUILDING PLAN
TYPE II - 2ND FLOOR
BUILDING 7

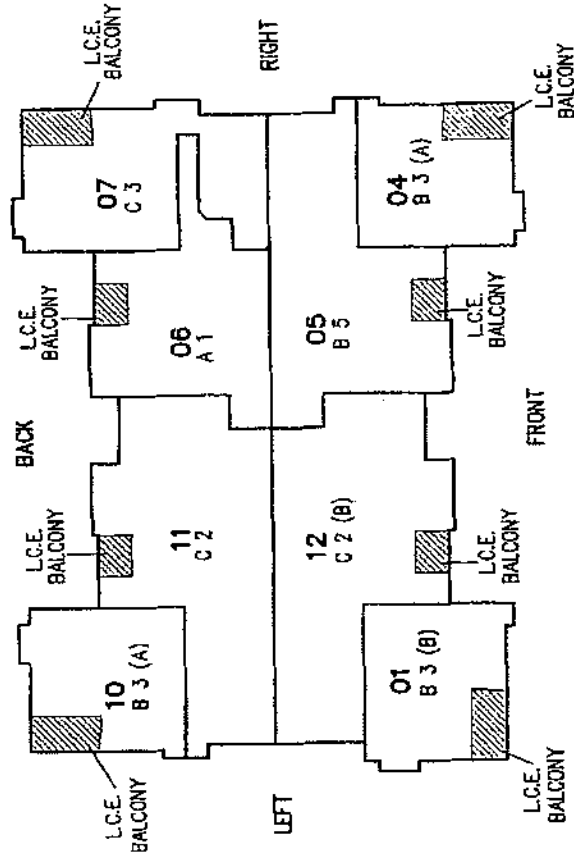

SCALE
1 inch = 30 ft.

(L.C.E.) = LIMITED COMMON ELEMENT
(C.E.) = COMMON ELEMENT

EXHIBIT: SHEET: 22

PREPARED BY:

ATLANTIC & GULF SURVEYING CO.
LAND & ENGINEERING SURVEYS
LICENSED BUSINESS # 8228
8488 POWERS AVENUE
JACKSONVILLE, FLORIDA 32256

Mirabella, a Condominium
CITY OF JACKSONVILLE, DUVAL COUNTY, FLORIDA

BUILDING PLAN
TYPE II - 3RD FLOOR
BUILDING 7

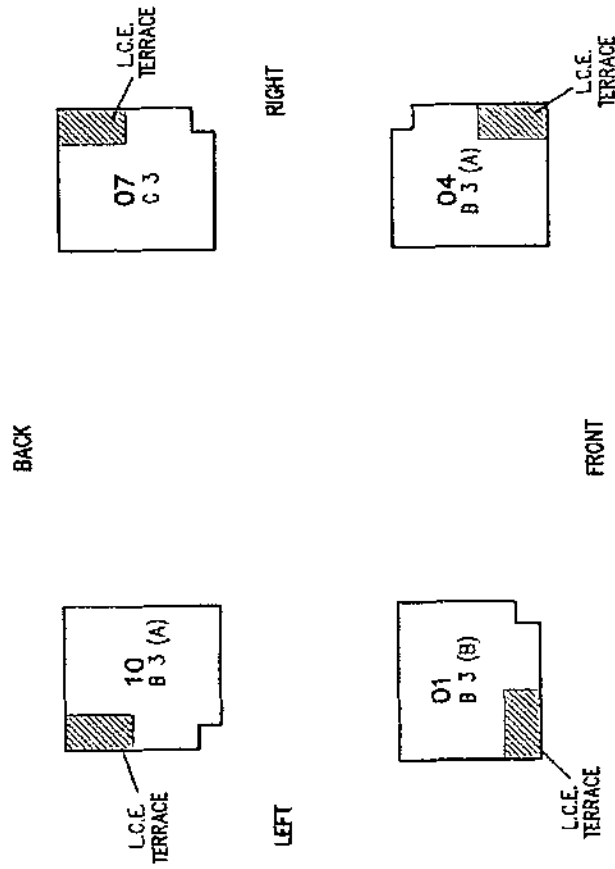

PREPARED BY:

ATLANTIC GULF SURVEYING CO.
 LAND & ENGINEERING SURVEYS
 LICENSED BUSINESS # 8228
 6485 POWERS AVENUE
 JACKSONVILLE, FLORIDA 32256

SCALE
1 inch = 30 ft.

(L.C.E.) = LIMITED COMMON ELEMENT
(C.E.) = COMMON ELEMENT

EXHIBIT: SHEET: 23

Mirabella, a Condominium
CITY OF JACKSONVILLE, DUVAL COUNTY, FLORIDA

BUILDING PLAN
TYPE II REVERSED - 2ND FLOOR
BUILDINGS 4, 14, & 28

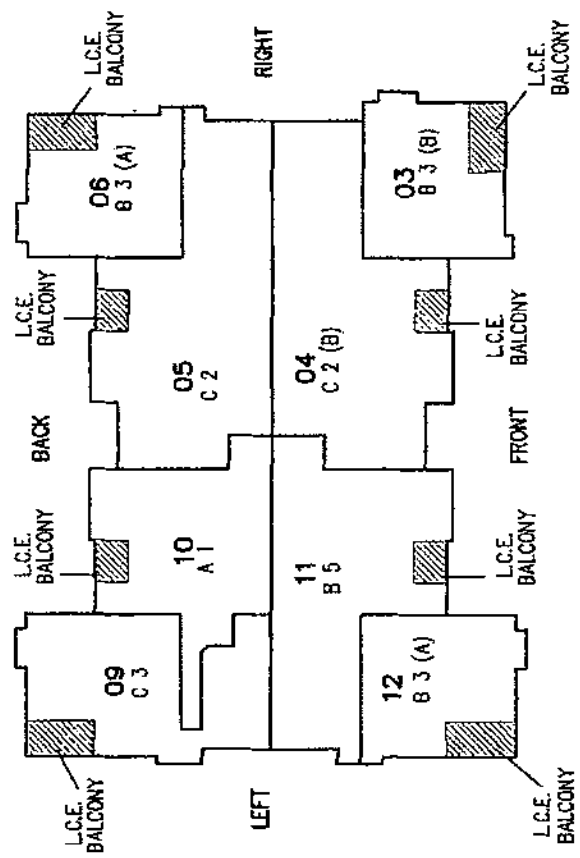

PREPARED BY:
ATLANTIC GULF SURVEYING CO.
 LAND & ENGINEERING SURVEYS
 LICENSED BUSINESS # 0226
 8466 POWERS AVENUE
 JACKSONVILLE, FLORIDA 32259

SCALE
1 inch = 30 ft.

(L.C.E.) = LIMITED COMMON ELEMENT
 (C.E.) = COMMON ELEMENT

EXHIBIT: SHEET: 25

Mirabella, a Condominium
CITY OF JACKSONVILLE, DUVAL COUNTY, FLORIDA

BUILDING PLAN
TYPE II REVERSED - 3RD FLOOR
BUILDINGS 4, 14, & 28

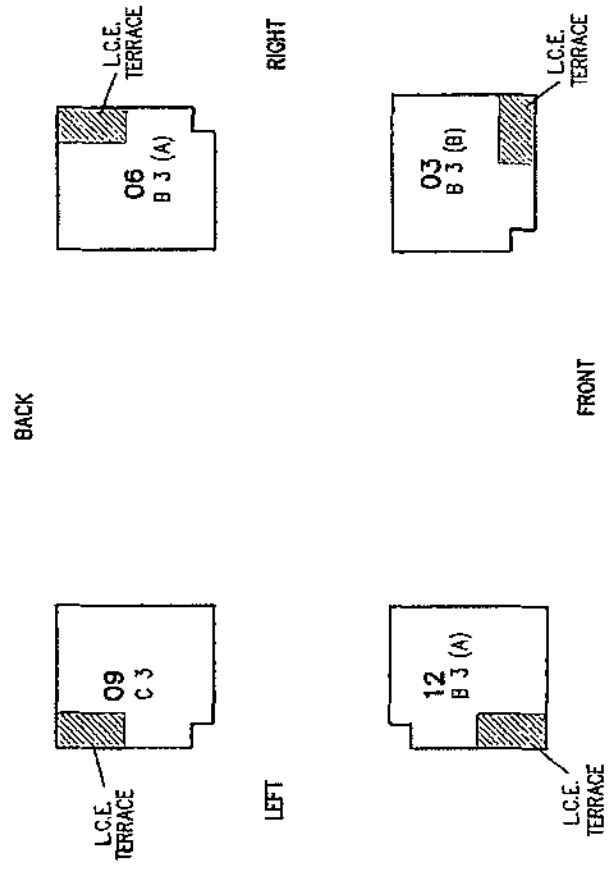

SCALE
1 inch = 30 ft.



 (L.C.E.) = LIMITED COMMON ELEMENT
 (C.E.) = COMMON ELEMENT

EXHIBIT: SHEET: 26

 PREPARED BY:
ATLANTIC ~ GULF SURVEYING CO.
 LAND & ENGINEERING SURVEYS
 LICENSED BUSINESS # 2226
 8485 POWERS AVENUE
 JACKSONVILLE, FLORIDA 32256

Mirabella, a Condominium

CITY OF JACKSONVILLE, DUVAL COUNTY, FLORIDA

BUILDING PLAN
TYPE III - 1ST FLOOR
BUILDINGS 6, 16, 18, 21, 23 & 24



PREPARED BY:
ATLANTIC ~ GULF SURVEYING CO.
 LAND & ENGINEERING SURVEYS
 LICENSED BUSINESS # 8226
 6455 POWERS AVENUE
 JACKSONVILLE, FLORIDA 32206





SCALE
1 inch = 30 ft.

EXHIBIT: SHEET: 27

Mirabella, a Condominium
CITY OF JACKSONVILLE, DUVAL COUNTY, FLORIDA

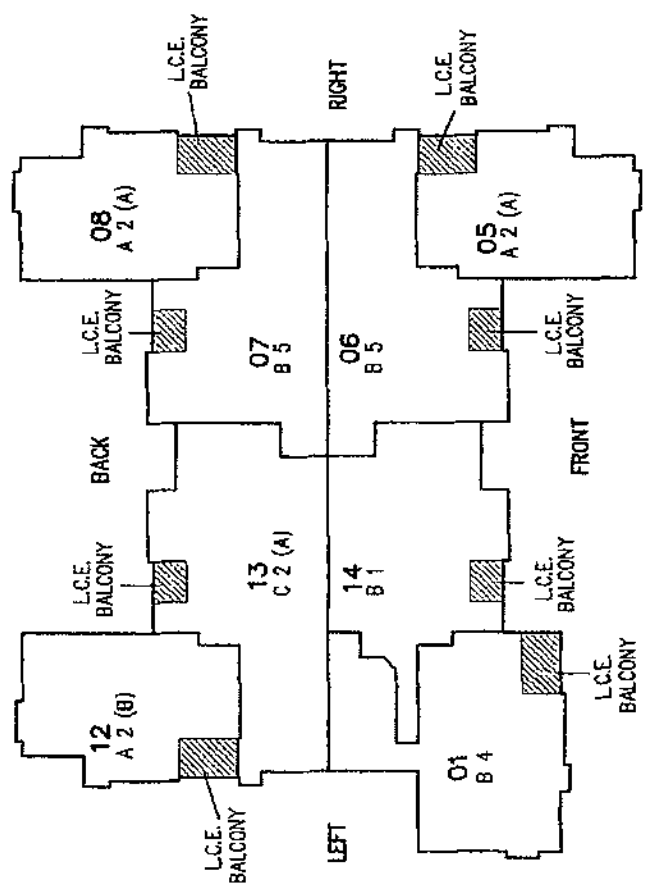
BUILDING PLAN
TYPE III - 2ND FLOOR
BUILDINGS 6, 16, 18, 21, 23 & 24



PREPARED BY:

ATLANTIC GULF SURVEYING CO.
 LAND & ENGINEERING SURVEYS
 LICENSED BUSINESS # 6226
 6445 POWERS AVENUE
 JACKSONVILLE, FLORIDA 32256

SCALE
1 inch = 30 ft.

(L.C.E.) = LIMITED COMMON ELEMENT
(C.E.) = COMMON ELEMENT

EXHIBIT: SHEET: 28

Mirabella, a Condominium
 CITY OF JACKSONVILLE, DUVAL COUNTY, FLORIDA

BUILDING PLAN
TYPE III REVERSED -- 1ST FLOOR
 BUILDINGS 19, 26 & 27

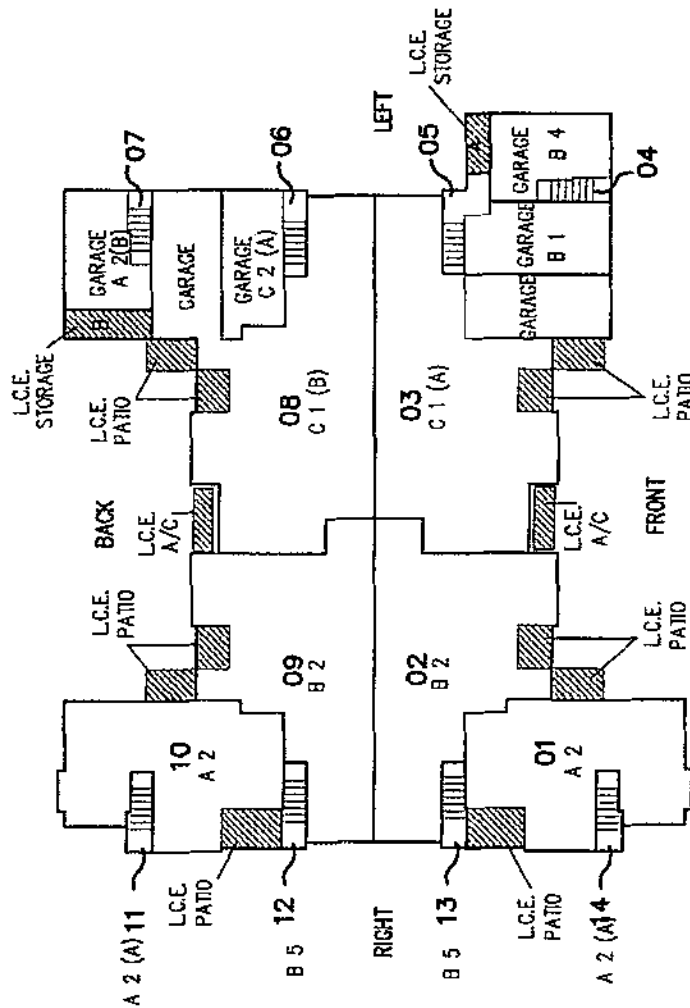

PREPARED BY:
ATLANTIC ~ GULF SURVEYING CO.
 LAND & ENGINEERING SURVEYS
 LICENSED BUSINESS # 0228
 6455 POWERS AVENUE
 JACKSONVILLE, FLORIDA 32256

(L.C.E.) = LIMITED COMMON ELEMENT
 (C.E.) = COMMON ELEMENT

SCALE
 1 inch = 30 ft.

EXHIBIT: SHEET: 29

Mirabella, a Condominium
CITY OF JACKSONVILLE, DUVAL COUNTY, FLORIDA

BUILDING PLAN
TYPE III REVERSED - 2ND FLOOR
BUILDINGS 19, 26 & 27

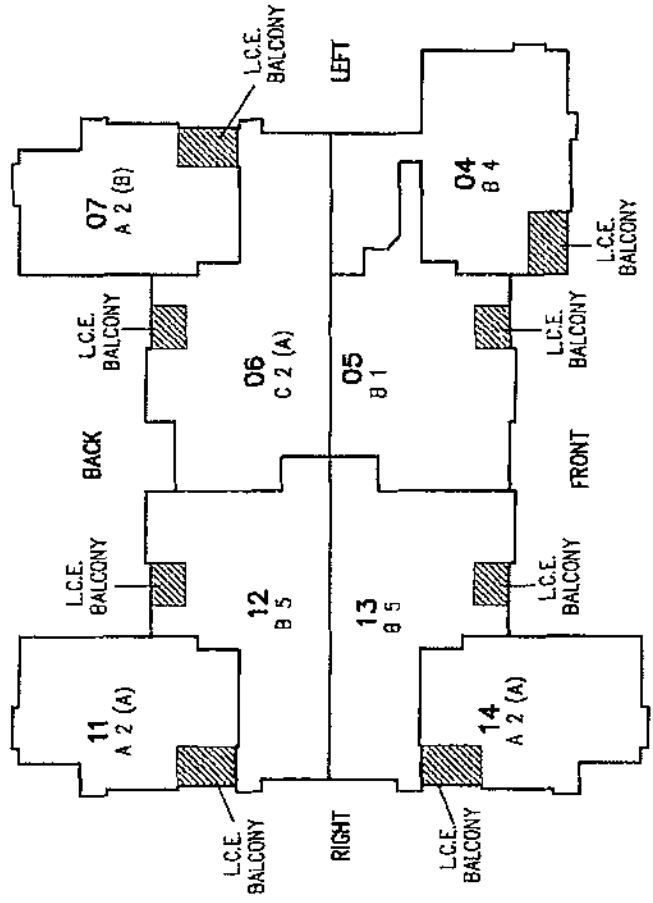

PREPARED BY:

ATLANTIC GULF SURVEYING CO.
 LAND & ENGINEERING SURVEYS
 LICENSED BUSINESS # 6226
 6485 POWERS AVENUE
 JACKSONVILLE, FLORIDA 32256

(L.C.E.) = LIMITED COMMON ELEMENT
(C.E.) = COMMON ELEMENT

SCALE
1 inch = 30 ft.

EXHIBIT: SHEET: 30

Mirabella, a Condominium
CITY OF JACKSONVILLE, DUVAL COUNTY, FLORIDA

BUILDING PLAN
TYPE IV - 1ST FLOOR
BUILDINGS 10, 13, & 22

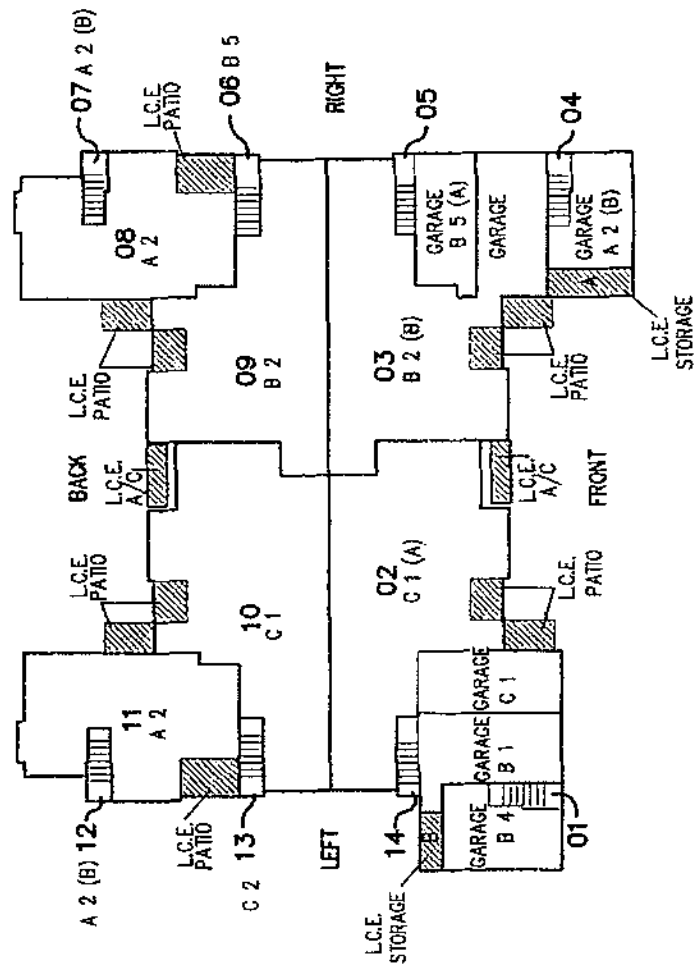

SCALE
1 inch = 30 ft.

(L.C.E.) = LIMITED COMMON ELEMENT
(C.E.) = COMMON ELEMENT

EXHIBIT: SHEET: 31

PREPARED BY:
ATLANTIC GULF SURVEYING CO.
 LAND & ENGINEERING SURVEYS
 LICENSED BUSINESS # 8228
 8405 POWERS AVENUE
 JACKSONVILLE, FLORIDA 32256

Mirabella, a Condominium
 CITY OF JACKSONVILLE, DUVAL COUNTY, FLORIDA

BUILDING PLAN
TYPE IV REVERSED - 1ST FLOOR
 BUILDINGS 17 & 30

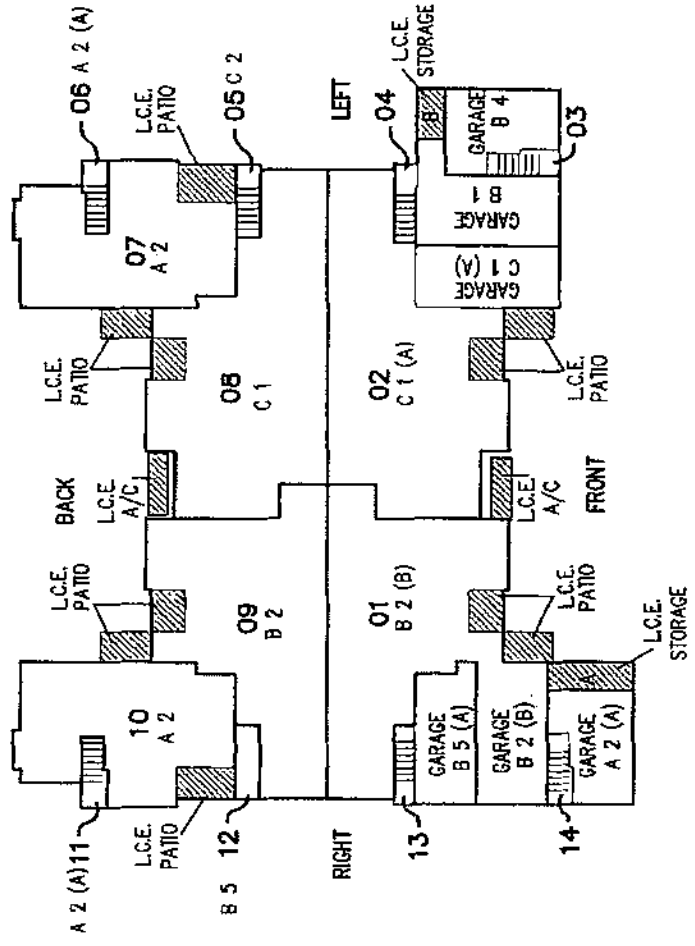

(L.C.E.) = LIMITED COMMON ELEMENT
 (C.E.) = COMMON ELEMENT

SCALE
 1 inch = 30 ft.

EXHIBIT: SHEET: 33

PREPARED BY:
ATLANTIC GULF SURVEYING CO.
 LAND & ENGINEERING SURVEYS
 LICENSED BUSINESS # 8238
 8445 POWERS AVENUE
 JACKSONVILLE, FLORIDA 32254

Mirabella, a Condominium
CITY OF JACKSONVILLE, DUVAL COUNTY, FLORIDA

BUILDING PLAN
TYPE IV REVERSED - 2ND FLOOR
BUILDINGS 17 & 30

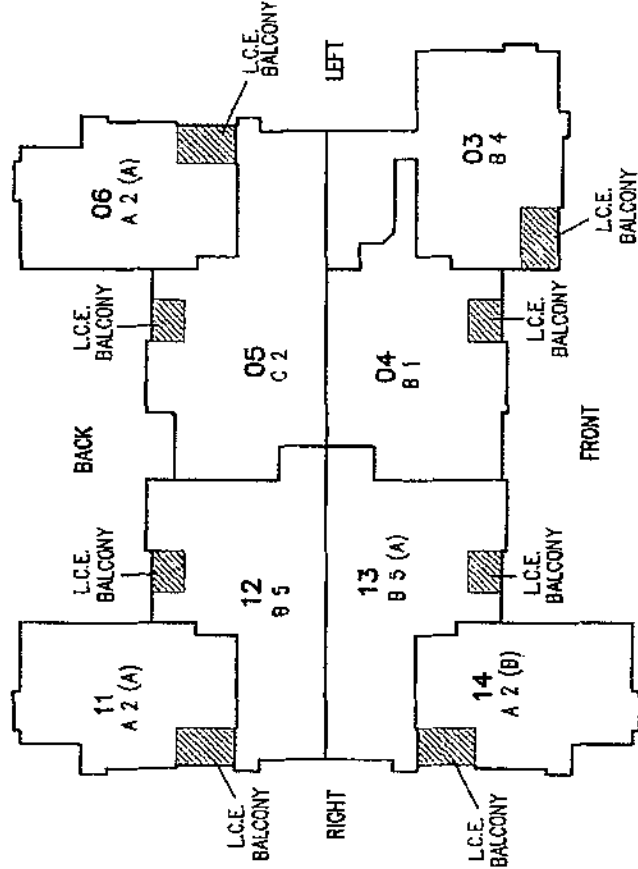

PREPARED BY:
ATLANTIC GULF SURVEYING CO.
 LAND & ENGINEERING SURVEYS
 LICENSED BUSINESS # B220
 8433 POWERS AVENUE
 JACKSONVILLE, FLORIDA 32216

(L.C.E.) = LIMITED COMMON ELEMENT
 (C.E.) = COMMON ELEMENT

SCALE
 1 inch = 30 ft.

EXHIBIT: SHEET: 34

Mirabella, a Condominium
CITY OF JACKSONVILLE, DUVAL COUNTY, FLORIDA

FLOORPLAN

- A1 UNIT #
- 106, 206, 311, 410,
 - 511, 706, 811, 911,
 - 1111, 1211, 1410, 1506,
 - 2011, 2511, 2810, 2906

SCALE
1 inch = 10 ft.

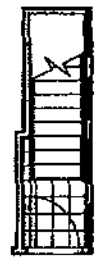
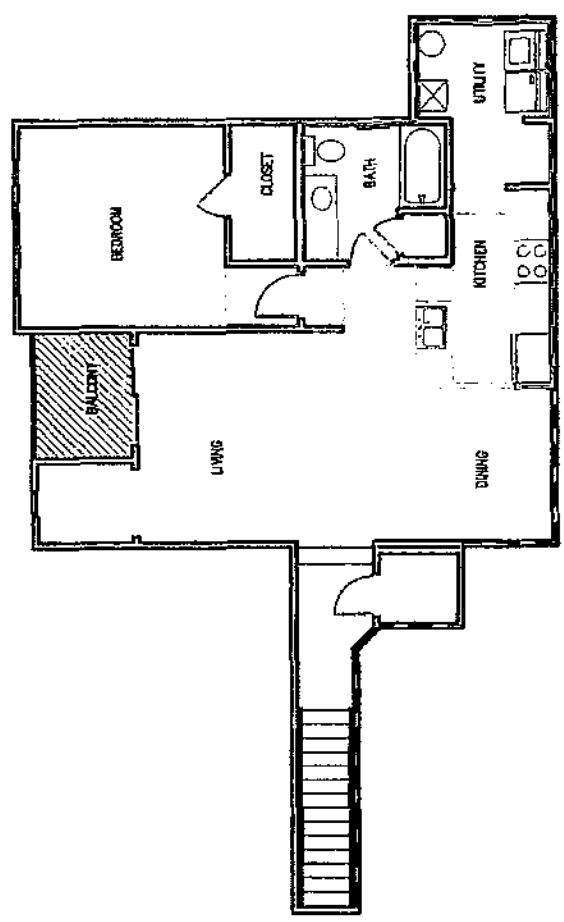

(-L.C.E.) = LIMITED COMMON ELEMENT
(C.E.) = COMMON ELEMENT

PREPARED BY:

ATLANTIC GULF LANDMARKS SURVEYING CO.
LAND & ENGINEERING SURVEYS
LICENSED BUSINESS # 0228
8445 POWERS AVENUE
JACKSONVILLE, FLORIDA 32258

EXHIBIT: SHEET: 35

Mirabella, a Condominium
 CITY OF JACKSONVILLE, DUVAL COUNTY, FLORIDA

FLOORPLAN

A2 UNIT #

- 604, 609, 1008, 1011,
- 1308, 1311, 1604, 1609,
- 1707, 1710, 1804, 1809,
- 1901, 1910, 2104, 2109,
- 2208, 2211, 2304, 2309,
- 2404, 2409, 2601, 2610,
- 2701, 2710, 3007, 3010

VARIATION A UNIT #

- 605, 608, 1007, 1012,
- 1307, 1312, 1605, 1608,
- 1706, 1711, 1805, 1808,
- 1911, 1914, 2105, 2108,
- 2207, 2212, 2305, 2308,
- 2405, 2408, 2611, 2614,
- 2711, 2714, 3006, 3011

VARIATION B UNIT #

- 612, 1004, 1304, 1612,
- 1714, 1812, 1907, 2112,
- 2204, 2312, 2412, 2607,
- 2707, 3014

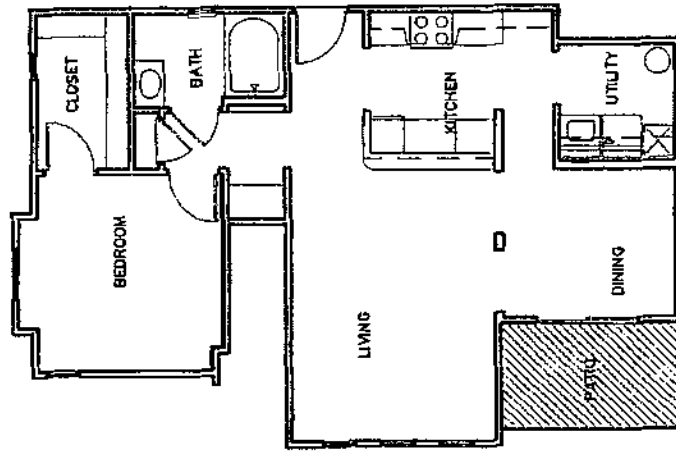

SCALE
 1 inch = 10 ft.

VARIATION A

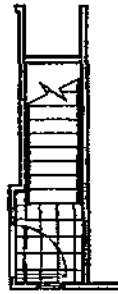

VARIATION B

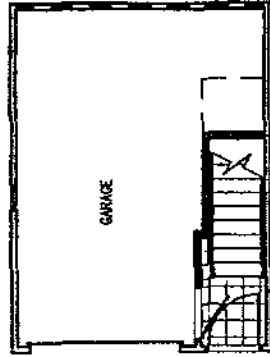

PREPARED BY:
ATLANTIC GULF SURVEYING CO.
 LAND & ENGINEERING SURVEYS
 LICENSED BUSINESS # 8228
 8448 POWERS AVENUE
 JACKSONVILLE, FLORIDA 32258

(L.C.E.) = LIMITED COMMON ELEMENT
 (C.E.) = COMMON ELEMENT

EXHIBIT: SHEET: 36

Mirabella, a Condominium
CITY OF JACKSONVILLE, DUVAL COUNTY, FLORIDA

FLOORPLAN



A3

UNIT #

110, 210, 307, 507,
807, 907, 1107, 1207,
1510, 2007, 2507, 2910

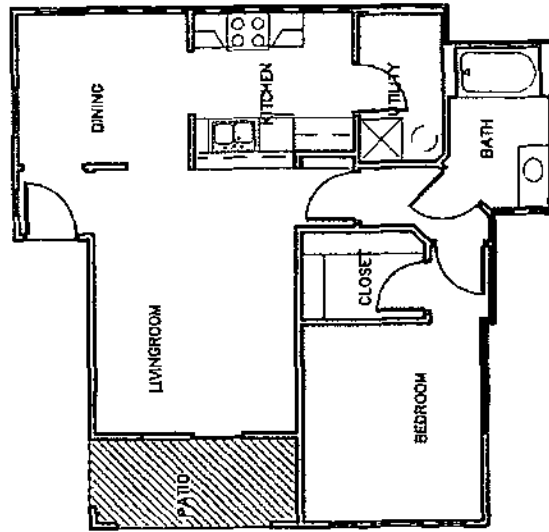
SCALE
1 inch = 10 ft.



 (L.C.E.) = LIMITED COMMON ELEMENT
 (C.E.) = COMMON ELEMENT



 PREPARED BY:
ATLANTIC GOLF SURVEYING CO.
 LAND & ENGINEERING SURVEYS
 LICENSED BUSINESS # 4326
 9408 POWERS AVENUE
 JACKSONVILLE, FLORIDA 32218

EXHIBIT: SHEET: 37

Mirabella, a Condominium
CITY OF JACKSONVILLE, DUVAL COUNTY, FLORIDA

FLOORPLAN

B1 UNIT #

- 614, 1014, 1314, 1614,
- 1704, 1814, 1905, 2114,
- 2214, 2314, 2414, 2605,
- 2705, 3004

SCALE
1 inch = 10 ft.

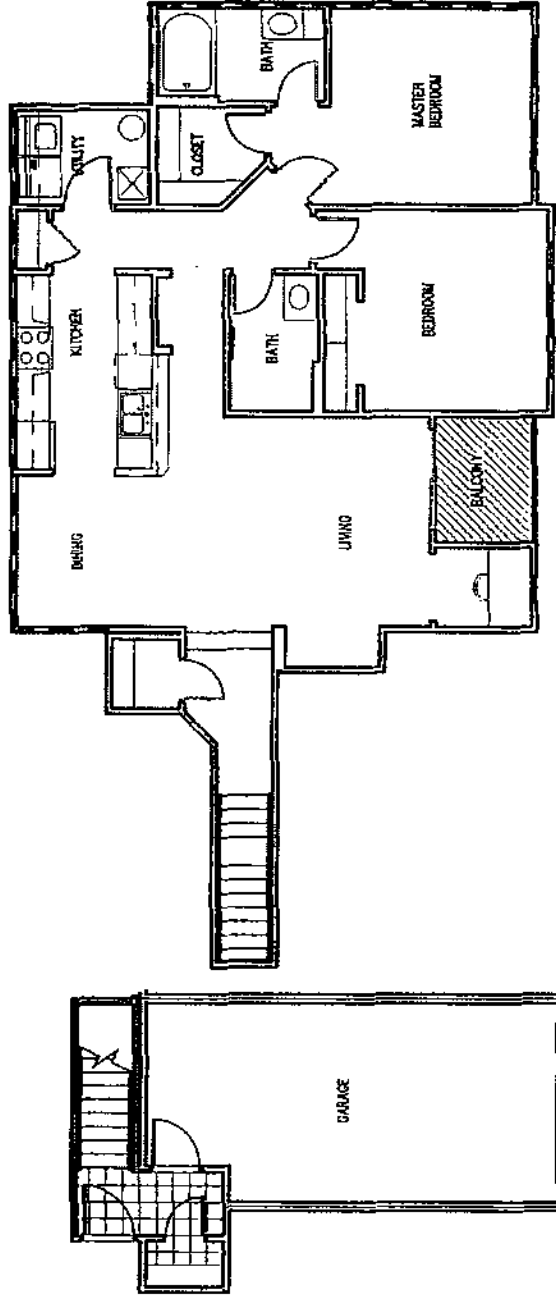

2ND FLOOR

1ST FLOOR

PREPARED BY:
ATLANTIC GULF SURVEYING CO.
 LAND & ENGINEERING SURVEYS
 LICENSED BUSINESS # 9326
 6405 POWERS AVENUE
 JACKSONVILLE, FLORIDA 32246

(L.C.E.) = LIMITED COMMON ELEMENT
 (C.E.) = COMMON ELEMENT

EXHIBIT: SHEET: 38

Mirabella, a Condominium
 CITY OF JACKSONVILLE, DUVAL COUNTY, FLORIDA

FLOORPLAN

B2 UNIT #

- 603, 610, 1009, 1309,
- 1603, 1610, 1709, 1803,
- 1810, 1902, 1909, 2103,
- 2110, 2209, 2310, 2403,
- 2410, 2602, 2609, 2702,
- 2709, 3009

VARIATION A UNIT #

- 103, 108, 203, 208,
- 301, 309, 401, 408,
- 501, 509, 703, 708,
- 801, 809, 901, 909,
- 1101, 1109, 1201, 1209,
- 1401, 1408, 1503, 1508,
- 2001, 2009, 2501, 2508,
- 2801, 2808, 2903, 2908

VARIATION B UNIT #

- 1003, 1303, 1701, 2203,
- 3001

SCALE
 1 inch = 10 ft.

VARIATION A

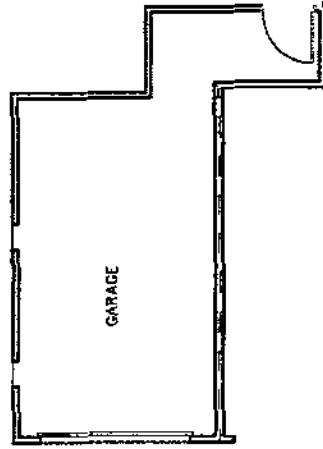

VARIATION B

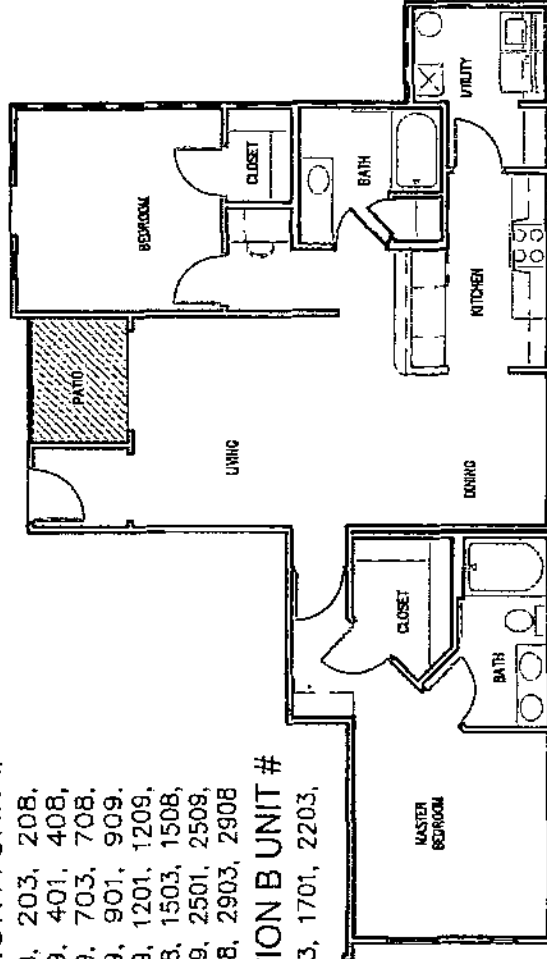
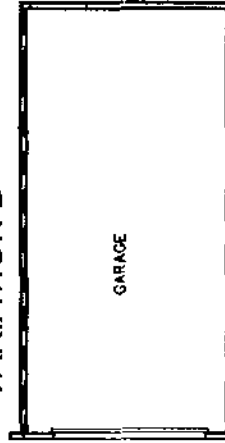

(L.C.E.) = LIMITED COMMON ELEMENT
 (C.E.) = COMMON ELEMENT

PREPARED BY:
ATLANTIC ~ GULF SURVEYING CO.
 LAND & ENGINEERING SURVEYS
 LICENSED BUSINESS # 0228
 8455 POWERS AVENUE
 JACKSONVILLE, FLORIDA 32250

Mirabella, a Condominium
CITY OF JACKSONVILLE, DUVAL COUNTY, FLORIDA

FLOORPLAN

B3

UNIT #

- 111, 211, 306, 506,
- 806, 906, 1106, 1206,
- 1511, 2006, 2506, 2911

VARIATION A UNIT #

- 104, 204, 313, 406,
- 412, 513, 704, 710,
- 813, 913, 1113, 1213,
- 1406, 1412, 1504, 2013,
- 2513, 2806, 2812, 2904

VARIATION B UNIT #

- 101, 201, 303, 403,
- 503, 701, 803, 903,
- 1103, 1203, 1403, 1501,
- 2003, 2503, 2803, 2901

SCALE
 1 inch = 10 ft.

VARIATION A

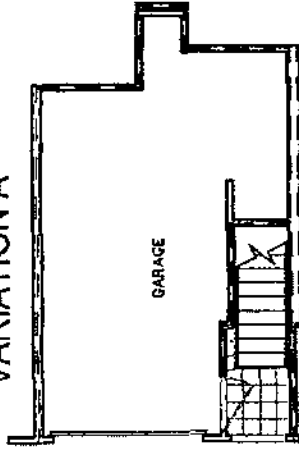

VARIATION B

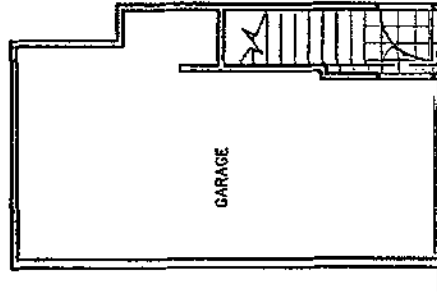

1ST FLOOR

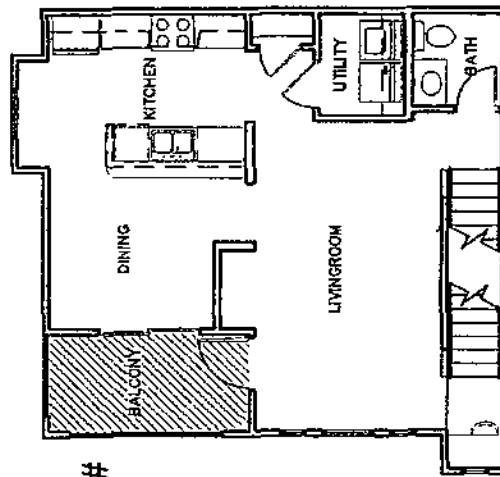

2ND FLOOR

(L.C.E.) = LIMITED COMMON ELEMENT
 (C.E.) = COMMON ELEMENT

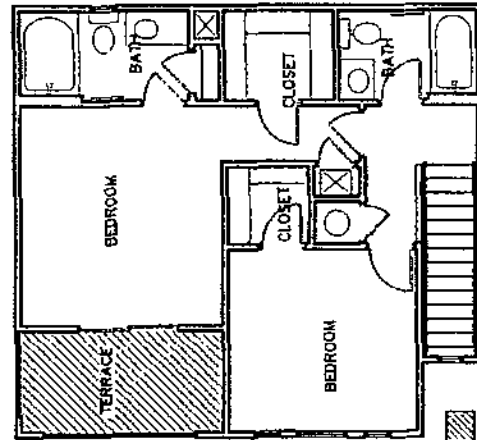

3RD FLOOR

PREPARED BY:
ATLANTIC ~ GULF SURVEYING CO.
 LAND & ENGINEERING SURVEYS
 LICENSED BUSINESS # 8224
 8488 POWERS AVENUE
 JACKSONVILLE, FLORIDA 32256

EXHIBIT:

SHEET: 40

Mirabella, a Condominium
CITY OF JACKSONVILLE, DUVAL COUNTY, FLORIDA

FLOORPLAN

B4 UNIT #
601, 1001, 1301, 1601,
1703, 1801, 1904, 2101,
2201, 2301, 2401, 2604,
2704, 3003

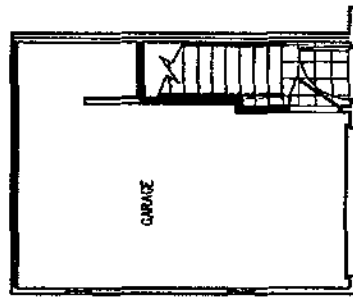

1ST FLOOR

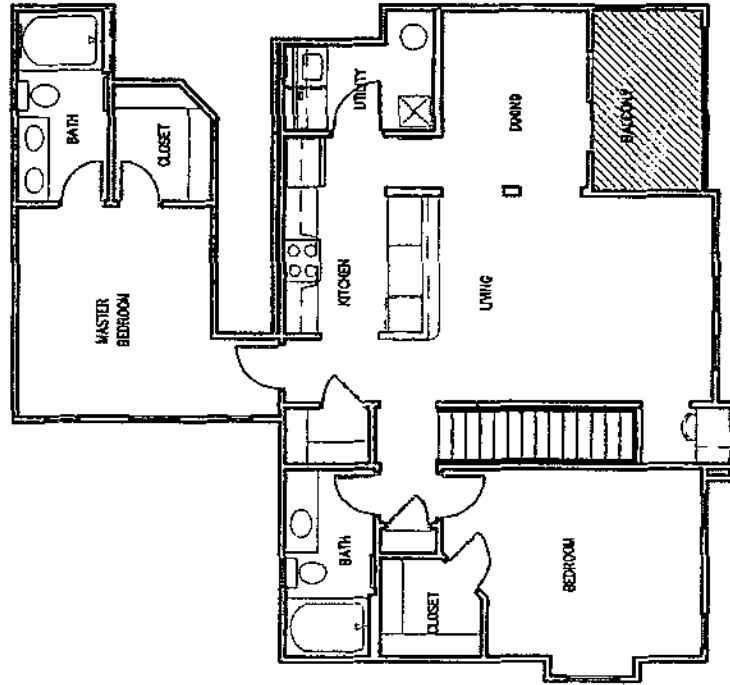

2ND FLOOR

PREPARED BY:
ATLANTIC & GULF SURVEYING CO.
 LAND & ENGINEERING SURVEYS
 LICENSED BUSINESS # 8226
 8488 POWERS AVENUE
 JACKSONVILLE, FLORIDA 32256

(L.C.E.) = LIMITED COMMON ELEMENT
(C.E.) = COMMON ELEMENT

SCALE
1 inch = 10 ft.

EXHIBIT: SHEET: 41

Mirabella, a Condominium
CITY OF JACKSONVILLE, DUVAL COUNTY, FLORIDA

FLOORPLAN

B5

UNIT #

- 105, 205, 312, 411,
- 512, 606, 607, 705,
- 812, 912, 1006, 1112,
- 1212, 1306, 1411, 1505,
- 1606, 1607, 1712, 1806,
- 1807, 1912, 1913, 2012,
- 2106, 2107, 2206, 2306,
- 2307, 2406, 2407, 2512,
- 2612, 2613, 2712, 2713,
- 2811, 2905, 3012

VARIATION A UNIT #

- 1005, 1305, 1713, 2205,
- 3013

SCALE
 1 inch = 10 ft.



1ST FLOOR

VARIATION A

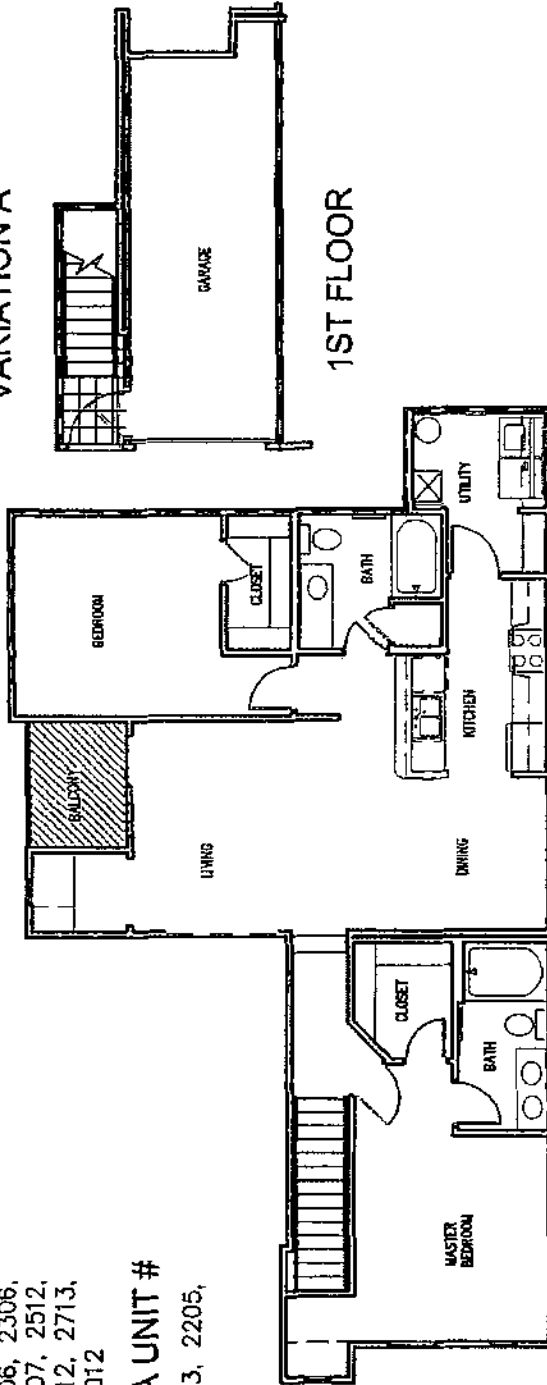

2ND FLOOR

(L.C.E.) = LIMITED COMMON ELEMENT
 (C.E.) = COMMON ELEMENT

PREPARED BY:

ATLANTIC & GULF SURVEYING CO.
 LAND & ENGINEERING SURVEYS
 LICENSED BUSINESS # 6228
 6435 POWERS AVENUE
 JACKSONVILLE, FLORIDA 32266

Mirabella, a Condominium
CITY OF JACKSONVILLE, DUVAL COUNTY, FLORIDA

FLOORPLAN

SCALE
 1 inch = 10 ft.

- C1 UNIT #**
 102, 109, 202, 209,
 302, 308, 402, 502,
 508, 702, 802, 808,
 902, 908, 1010, 1102,
 1108, 1202, 1208, 1310,
 1402, 1502, 1509, 1708,
 2002, 2008, 2210, 2502,
 2508, 2802, 2902, 2909,
 3008

- VARIATION A UNIT #**
 602, 1002, 1302, 1602,
 1702, 1802, 1903, 2102,
 2202, 2302, 2402, 2603,
 2703, 3002

- VARIATION B UNIT #**
 611, 1611, 1811, 1908,
 2111, 2311, 2411, 2608,
 2708

- VARIATION C UNIT #**
 407, 709, 1407,
 2807

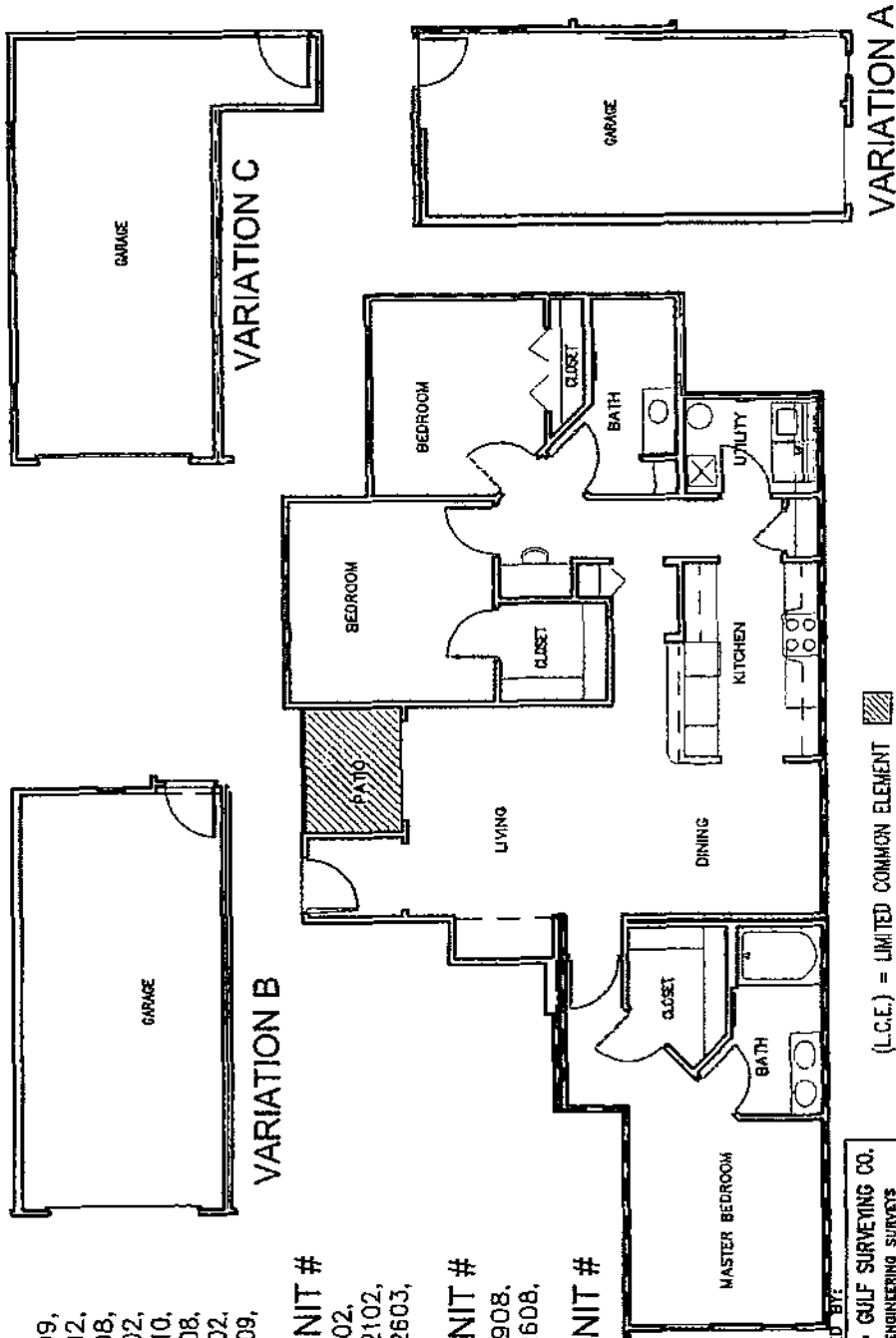

PREPARED BY:
ATLANTIC GULF SURVEYING CO.
 LAND & ENGINEERING SURVEYS
 LICENSED BUSINESS # 0210
 6465 POWERS AVENUE
 JACKSONVILLE, FLORIDA 32255

(L.C.E.) = LIMITED COMMON ELEMENT
 (C.E.) = COMMON ELEMENT

EXHIBIT: SHEET: 43

Mirabella, a Condominium

CITY OF JACKSONVILLE, DUVAL COUNTY, FLORIDA

FLOORPLAN

SCALE
1 inch = 10 ft.

C2 UNIT #

- 112, 212, 305, 405,
- 505, 711, 805, 905,
- 1013, 1105, 1205, 1313,
- 1405, 1512, 1705, 2005,
- 2213, 2505, 2805, 2912,
- 3005

VARIATION A UNIT #

- 613, 1613, 1813, 1906,
- 2113, 2313, 2413, 2606,
- 2706

VARIATION B UNIT #

- 113, 213, 304, 404,
- 504, 712, 804, 904,
- 1104, 1204, 1404, 1513,
- 2004, 2504, 2804, 2913

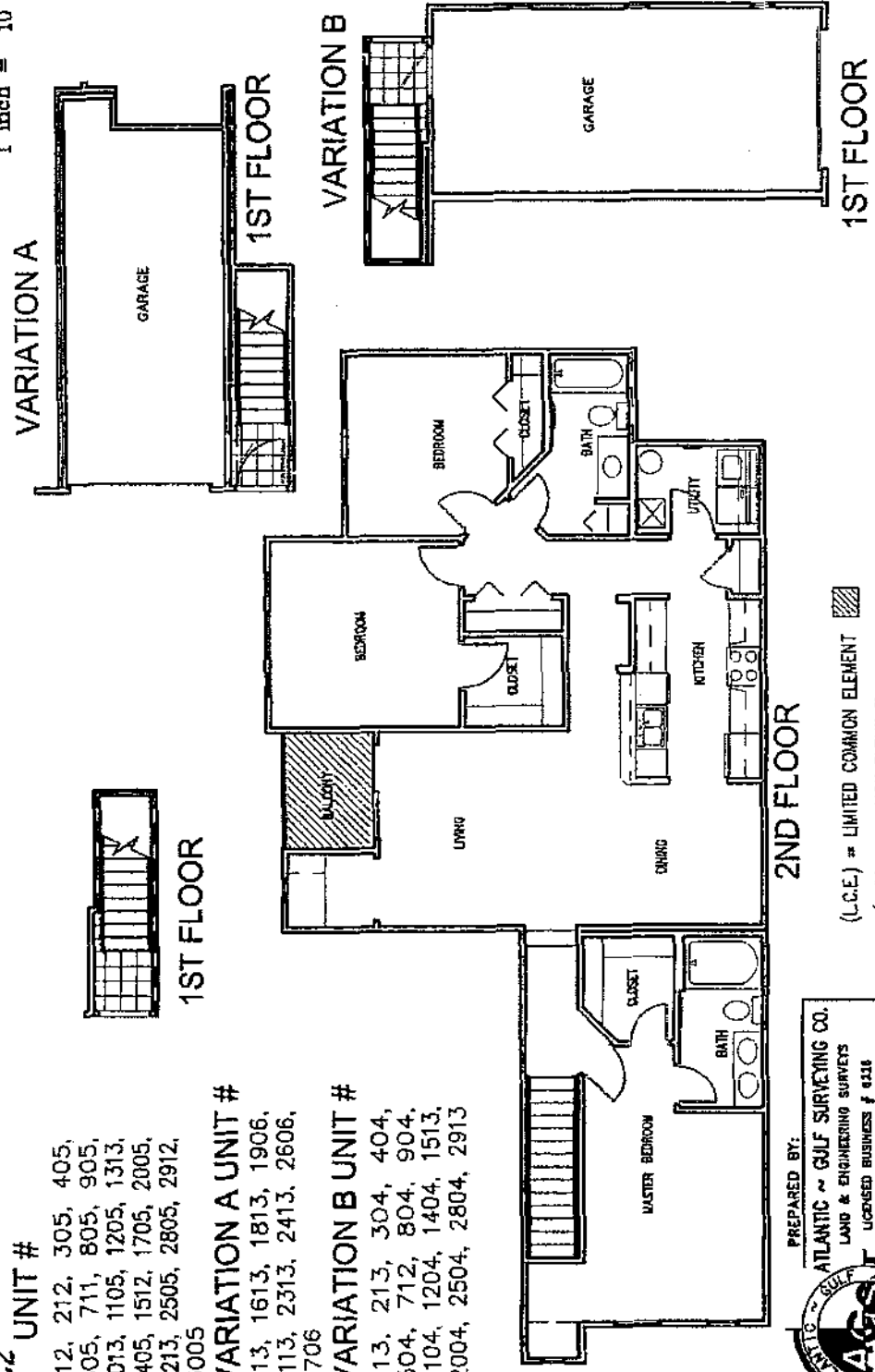

2ND FLOOR

(L.C.E.) = LIMITED COMMON ELEMENT
(C.E.) = COMMON ELEMENT

PREPARED BY:
ATLANTIC ~ GULF SURVEYING CO.
 LAND & ENGINEERING SURVEYS
 LICENSED BUSINESS # 6216
 8465 POWERS AVENUE
 JACKSONVILLE, FLORIDA 32256

EXHIBIT: SHEET: 44

Mirabella, a Condominium
CITY OF JACKSONVILLE, DUVAL COUNTY, FLORIDA

FLOORPLAN

- C3 UNIT #
- 107, 207, 310, 409,
 - 510, 707, 810, 910,
 - 1110, 1210, 1409, 1507,
 - 2010, 2510, 2809, 2907

SCALE
1 inch = 10 ft.

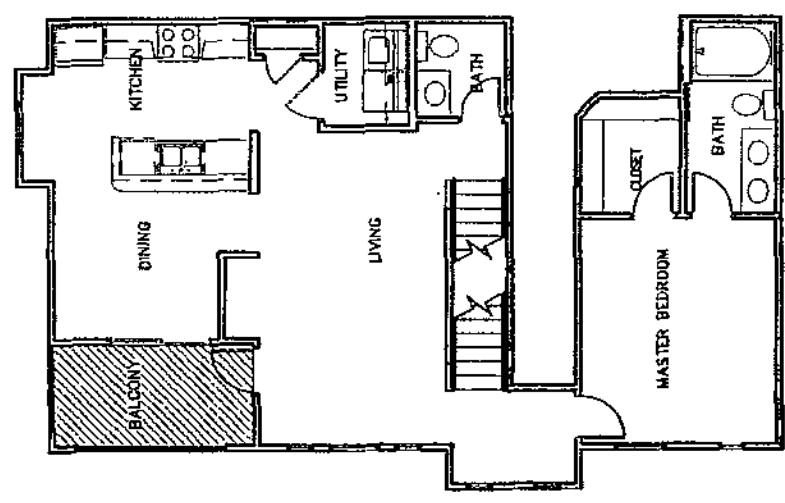
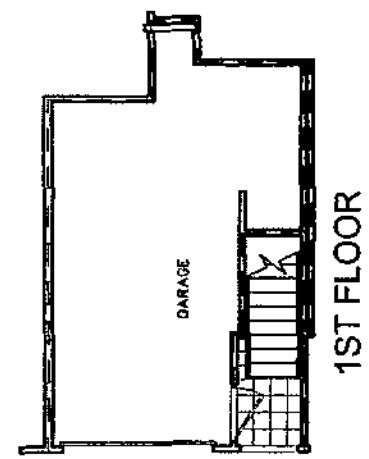

(L.C.E.) = LIMITED COMMON ELEMENT

(C.E.) = COMMON ELEMENT

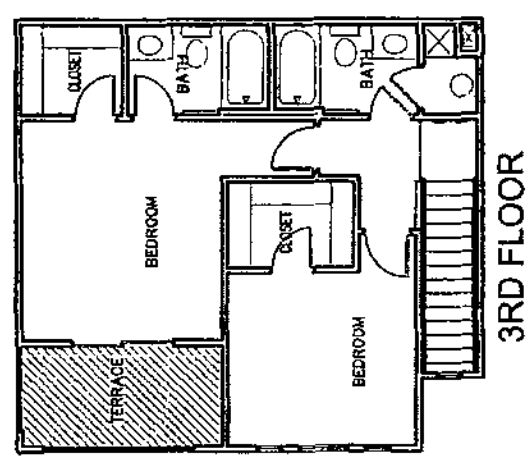

PREPARED BY:

ATLANTIC GULF SURVEYING CO.
 LAND & ENGINEERING SURVEYS
 LICENSED BUSINESS # 6226
 6400 POWERS AVENUE
 JACKSONVILLE, FLORIDA 32256

EXHIBIT: SHEET: 45

Mirabella, a Condominium
CITY OF JACKSONVILLE, DUVAL COUNTY, FLORIDA

ELEVATION TABULATION

BUILDING NO.	FINISHED FLOOR ELEVATION	BUILDING NO.	FINISHED FLOOR ELEVATION
Building No. 1	41.70	Building No. 16	39.25
Building No. 2	41.90	Building No. 17	39.20
Building No. 3	42.04	Building No. 18	39.21
Building No. 4	42.01	Building No. 19	38.93
Building No. 5	39.92	Building No. 20	38.95
Building No. 6	39.02	Building No. 21	38.91
Building No. 7	38.96	Building No. 22	39.07
Building No. 8	39.08	Building No. 23	38.98
Building No. 9	38.99	Building No. 24	39.39
Building No. 10	38.96	Building No. 25	39.10
Building No. 11	39.12	Building No. 26	39.22
Building No. 12	38.91	Building No. 27	39.33
Building No. 13	38.83	Building No. 28	39.70
Building No. 14	38.89	Building No. 29	39.60
Building No. 15	38.87	Building No. 30	39.74

EXHIBIT: SHEET: 46

PREPARED BY:

ATLANTIC GULF SURVEYING CO.
 LAND & ENGINEERING SURVEYS
 LICENSED BUSINESS # 8226
 6448 POWERS AVENUE
 JACKSONVILLE, FLORIDA 32216

Mirabella, a Condominium
CITY OF JACKSONVILLE, DUVAL COUNTY, FLORIDA

BUILDING ELEVATION SCHEME
TYPE I & IR

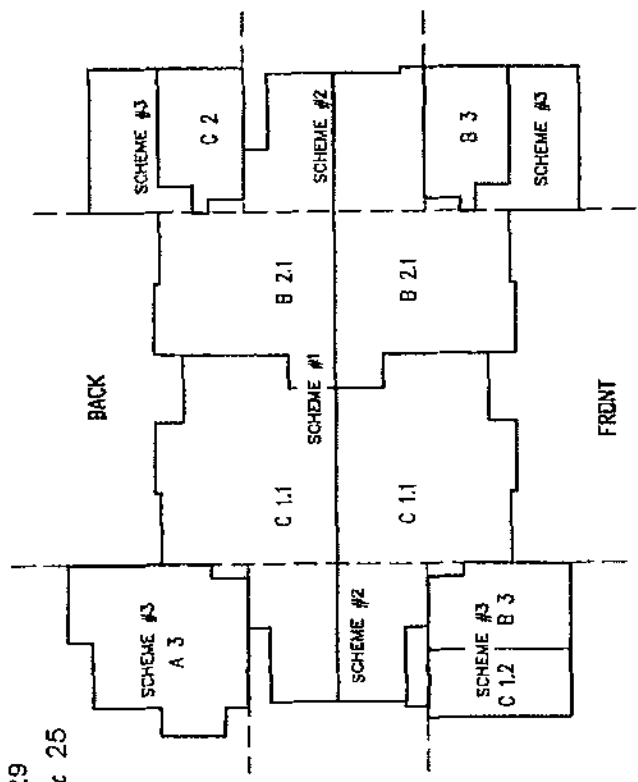
BUILDINGS 1, 2, 15, & 29
3, 5, 8, 9, 11, 12, 20 & 25



PREPARED BY:



ATLANTIC GULF SURVEYING CO.
LAND & ENGINEERING SURVEYS
LICENSED BUSINESS # 8228
6456 POWERS AVENUE
JACKSONVILLE, FLORIDA 32256

Mirabella, a Condominium
CITY OF JACKSONVILLE, DUVAL COUNTY, FLORIDA

BUILDING PLAN
TYPE II & IIR
BUILDINGS 7, 4, 14 & 28

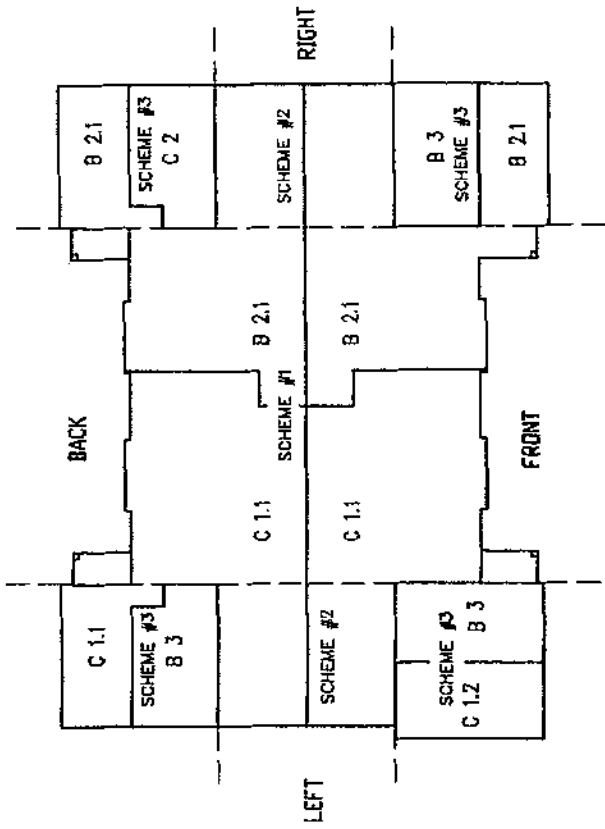

PREPARED BY:



ATLANTIC GULF SURVEYING CO.
LAND & ENGINEERING SURVEYS
LICENSED BUSINESS # 0220
6488 POWERS AVENUE
JACKSONVILLE, FLORIDA 32206

Mirabella, a Condominium
CITY OF JACKSONVILLE, DUVAL COUNTY, FLORIDA

BUILDING PLAN
TYPE III & IIR
BUILDINGS 6, 16, 18, 21, 23, 24
19, 26 & 27

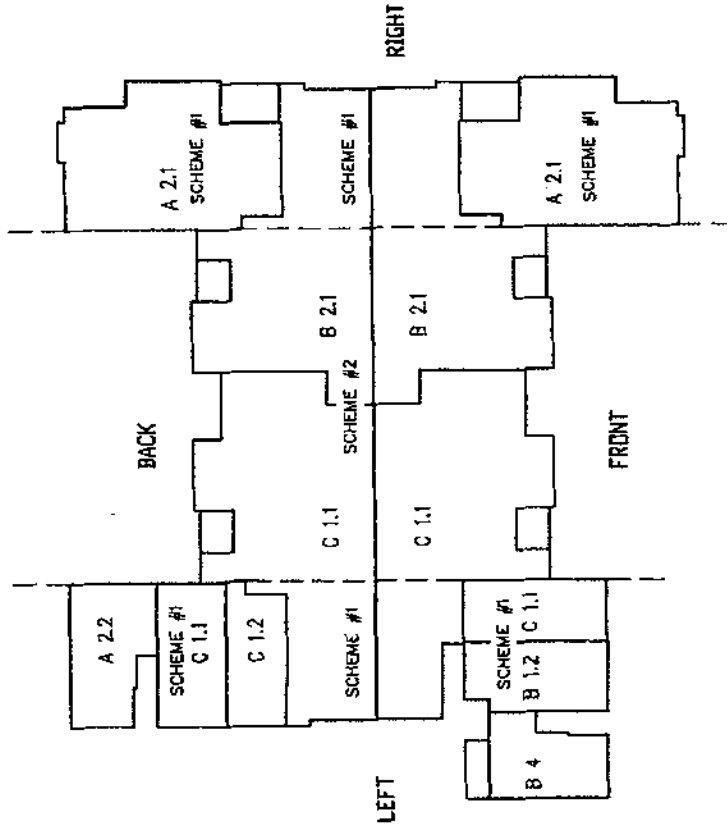

PREPARED BY:



ATLANTIC GULF SURVEYS CO.
LAND & ENGINEERING SURVEYS
LICENSED BUSINESS # 8228
6488 POWERS AVENUE
JACKSONVILLE, FLORIDA 32256

Mirabella, a Condominium
CITY OF JACKSONVILLE, DUVAL COUNTY, FLORIDA

BUILDING PLAN
TYPE IV & IVR
BUILDINGS 10, 13, 22, 17 & 30

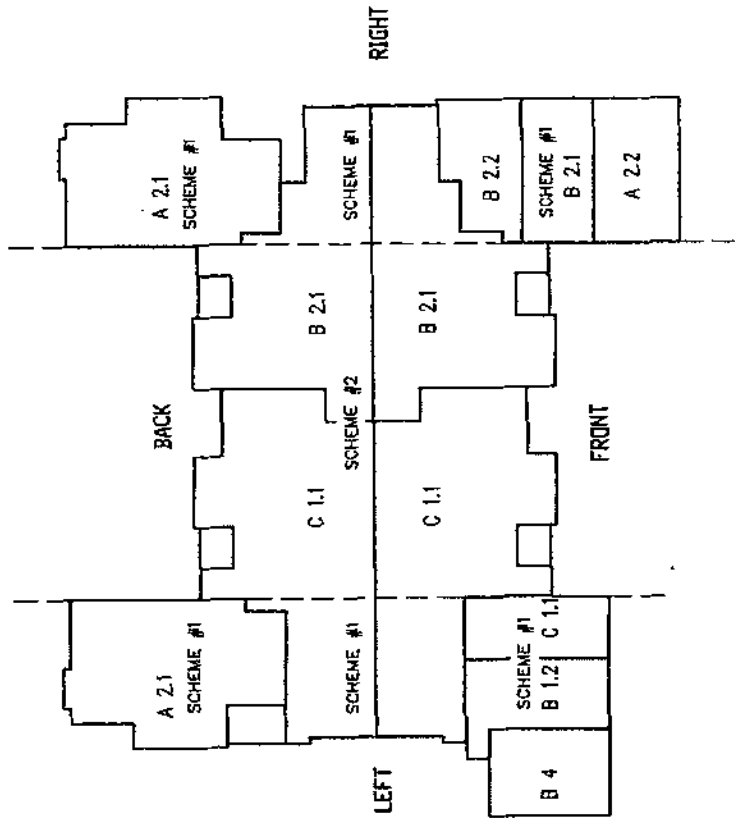

PREPARED BY:
ATLANTIC ~ GULF SURVEYING CO.
 LAND & ENGINEERING SURVEYS
 LICENSED BUSINESS # 6226
 8466 POWERS AVENUE
 JACKSONVILLE, FLORIDA 32256

Mirabella, a Condominium
CITY OF JACKSONVILLE, DUVAL COUNTY, FLORIDA

BUILDING ELEVATIONS
TYPE I, I R, II & II R

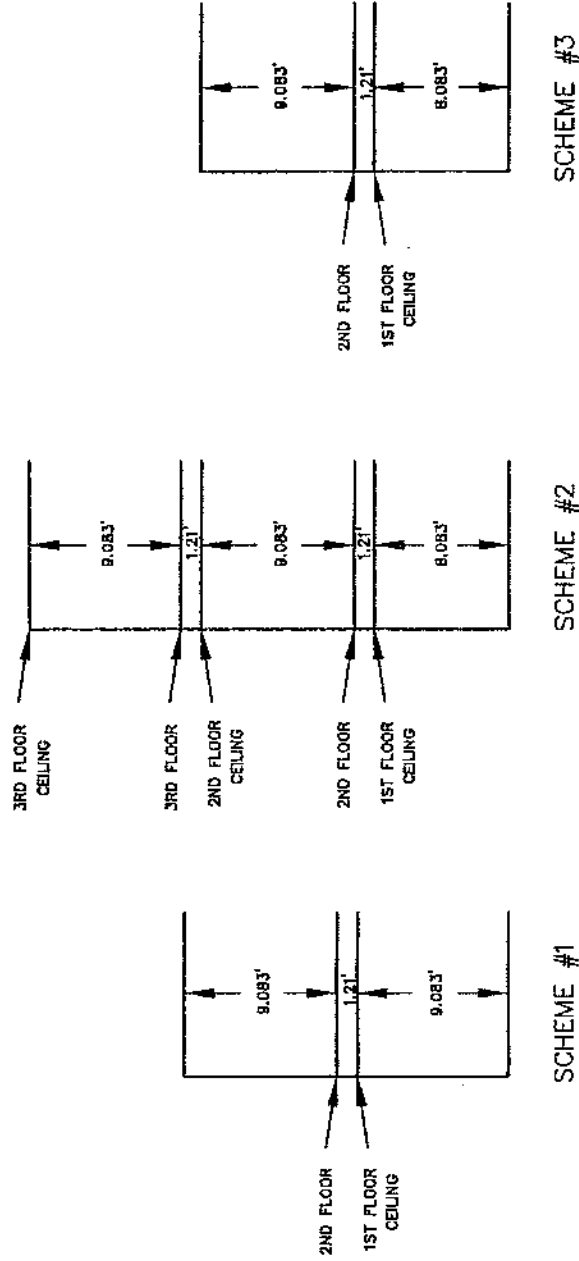

PREPARED BY:
ATLANTIC GULF SURVEYING CO.
 LAND & ENGINEERING SURVEYS
 LICENSED BUSINESS # 6226
 8455 POMEROY AVENUE
 JACKSONVILLE, FLORIDA 32269

EXHIBIT: SHEET: 51

Mirabella, a Condominium
CITY OF JACKSONVILLE, DUVAL COUNTY, FLORIDA

BUILDING ELEVATIONS
TYPE III, III R, IV & IV R

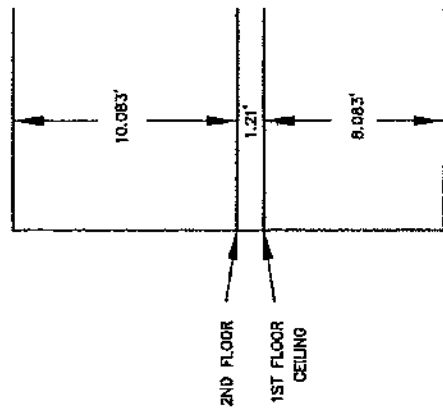

SCHEME #2

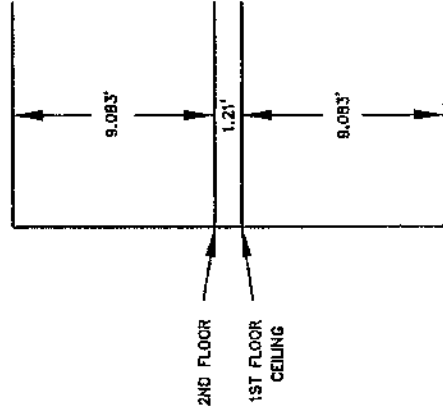

SCHEME #3

PREPARED BY:

ATLANTIC GULF SURVEYING CO.
LAND & ENGINEERING SURVEYS
LICENSED BUSINESS # 6226
8453 POWERS AVENUE
JACKSONVILLE, FLORIDA 32256

CLUBHOUSE FACILITY
FLOORPLAN
MiraBella, a Condominium
CITY OF JACKSONVILLE, DUVAL COUNTY, FLORIDA

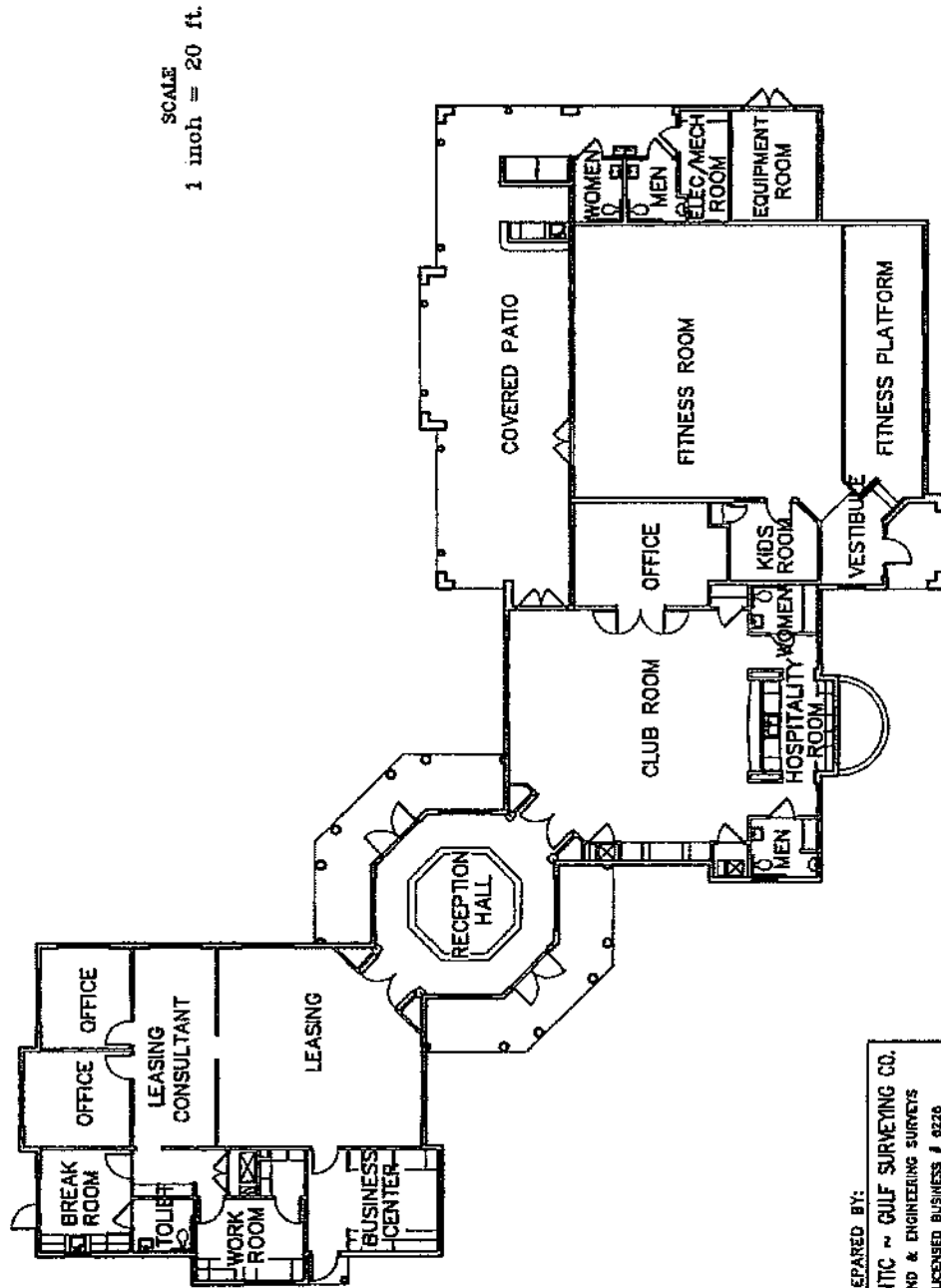

SCALE
1 inch = 20 ft.

PREPARED BY:
ATLANTIC & GULF SURVEYING CO.
LAND & ENGINEERING SURVEYS
LICENSED BUSINESS # 8226
6488 POWERS AVENUE
JACKSONVILLE, FLORIDA 32269

EXHIBIT: SHEET: 53

Mirabella, a Condominium
CITY OF JACKSONVILLE, DUVAL COUNTY, FLORIDA

UNIT TABULATION
UNIT TYPE AND SQUARE FOOTAGE

UNIT TYPE	COND. S.F.	PATIO/BALCONY S.F.	LANDING S.F.	GARAGE FLOOR	# OF GARAGES	TOTAL GARAGES	# OF UNITS	GROSS S.F.	TOTAL
A1	878	49	15	NONE	0	0	16	942	15072
A2	790	73	NONE	NONE	0	0	28	864	24192
A2 (A)	851	73	15	NONE	0	0	28	940	26320
A2 (B)	851	73	15	248	1	14	14	1188	16632
A3	732	66	NONE	NONE	0	0	12	798	9576
B1	1159	49	48	289	1	14	14	1545	21630
B2	1103	49	NONE	NONE	0	0	23	1152	26496
B2 (A)	1103	49	NONE	283	1	32	32	1435	45920
B2 (B)	1103	49	NONE	299	1	5	5	1451	7255
B3	1209	156	15	NONE	0	0	12	1380	16560
B3 (A)	1209	156	16	281	1	20	20	1662	33240
B3 (B)	1209	156	16	307	1	16	16	1688	27008
B4	1160	75	15	244	1	14	14	1273	17822
B5	1178	49	15	NONE	0	0	39	1242	48438
B5 (A)	1178	49	15	205	1	5	5	1447	7235

EXHIBIT "5"

PERCENTAGE OWNERSHIP AND
SHARES IN COMMON ELEMENTS

Mirabella
Percentage of Common Ownership

Unit #	Unit Type	Sq. Ft	% of owner
101	B3 (B)	1209	0.2639%
102	C1	1326	0.2895%
103	B2 (A)	1103	0.2408%
104	B3 (A)	1209	0.2639%
105	B5	1178	0.2572%
106	A1	878	0.1917%
107	C3	1574	0.3436%
108	B2 (A)	1103	0.2408%
109	C1	1326	0.2895%
110	A3	732	0.1598%
111	B3	1209	0.2639%
112	C2	1397	0.3050%
113	C2 (B)	1389	0.3032%
201	B3 (B)	1209	0.2639%
202	C1	1326	0.2895%
203	B2 (A)	1103	0.2408%
204	B3 (A)	1209	0.2639%
205	B5	1178	0.2572%
206	A1	878	0.1917%
207	C3	1574	0.3436%
208	B2 (A)	1103	0.2408%
209	C1	1326	0.2895%
210	A3	732	0.1598%
211	B3	1209	0.2639%
212	C2	1397	0.3050%
213	C2 (B)	1389	0.3032%
301	B2 (A)	1103	0.2408%
302	C1	1326	0.2895%
303	B3 (B)	1209	0.2639%
304	C2 (B)	1389	0.3032%
305	C2	1397	0.3050%
306	B3	1209	0.2639%
307	A3	732	0.1598%
308	C1	1326	0.2895%
309	B2 (A)	1103	0.2408%
310	C3	1574	0.3436%
311	A1	878	0.1917%
312	B5	1178	0.2572%
313	B3 (A)	1209	0.2639%
401	B2 (A)	1103	0.2408%
402	C1	1326	0.2895%
403	B3 (B)	1209	0.2639%
404	C2 (B)	1389	0.3032%
405	C2	1397	0.3050%
406	B3 (A)	1209	0.2639%
407	C1 (C)	1326	0.2895%
408	B2 (A)	1103	0.2408%
409	C3	1574	0.3436%

410	A1	878	0.1917%
411	B5	1178	0.2572%
412	B3 (A)	1209	0.2639%
501	B2 (A)	1103	0.2408%
502	C1	1326	0.2895%
503	B3 (B)	1209	0.2639%
504	C2 (B)	1389	0.3032%
505	C2	1397	0.3050%
506	B3	1209	0.2639%
507	A3	732	0.1598%
508	C1	1326	0.2895%
509	B2 (A)	1103	0.2408%
510	C3	1574	0.3436%
511	A1	878	0.1917%
512	B5	1178	0.2572%
513	B3 (A)	1209	0.2639%
601	B4	1160	0.2532%
602	C1 (A)	1326	0.2895%
603	B2	1103	0.2408%
604	A2	790	0.1725%
605	A2 (A)	851	0.1858%
606	B5	1178	0.2572%
607	B5	1178	0.2572%
608	A2 (A)	851	0.1858%
609	A2	790	0.1725%
610	B2	1103	0.2408%
611	C1 (B)	1326	0.2895%
612	A2 (B)	851	0.1858%
613	C2 (A)	1397	0.3050%
614	B1	1159	0.2530%
701	B3 (B)	1209	0.2639%
702	C1	1326	0.2895%
703	B2 (A)	1103	0.2408%
704	B3 (A)	1209	0.2639%
705	B5	1178	0.2572%
706	A1	878	0.1917%
707	C3	1574	0.3436%
708	B2 (A)	1103	0.2408%
709	C1 (C)	1326	0.2895%
710	B3 (A)	1209	0.2639%
711	C2	1397	0.3050%
712	C2 (B)	1389	0.3032%
801	B2 (A)	1103	0.2408%
802	C1	1326	0.2895%
803	B3 (B)	1209	0.2639%
804	C2 (B)	1389	0.3032%
805	C2	1397	0.3050%
806	B3	1209	0.2639%
807	A3	732	0.1598%
808	C1	1326	0.2895%
809	B2 (A)	1103	0.2408%
810	C3	1574	0.3436%

811	A1	878	0.1917%
812	B5	1178	0.2572%
813	B3 (A)	1209	0.2639%
901	B2 (A)	1103	0.2408%
902	C1	1326	0.2895%
903	B3 (B)	1209	0.2639%
904	C2 (B)	1389	0.3032%
905	C2	1397	0.3050%
906	B3	1209	0.2639%
907	A3	732	0.1598%
908	C1	1326	0.2895%
909	B2 (A)	1103	0.2408%
910	C3	1574	0.3436%
911	A1	878	0.1917%
912	B5	1178	0.2572%
913	B3 (A)	1209	0.2639%
1001	B4	1160	0.2532%
1002	C1 (A)	1326	0.2895%
1003	B2 (B)	1103	0.2408%
1004	A2 (B)	851	0.1858%
1005	B5 (A)	1178	0.2572%
1006	B5	1178	0.2572%
1007	A2 (A)	851	0.1858%
1008	A2	790	0.1725%
1009	B2	1103	0.2408%
1010	C1	1326	0.2895%
1011	A2	790	0.1725%
1012	A2 (A)	851	0.1858%
1013	C2	1397	0.3050%
1014	B1	1159	0.2530%
1101	B2 (A)	1103	0.2408%
1102	C1	1326	0.2895%
1103	B3 (B)	1209	0.2639%
1104	C2 (B)	1389	0.3032%
1105	C2	1397	0.3050%
1106	B3	1209	0.2639%
1107	A3	732	0.1598%
1108	C1	1326	0.2895%
1109	B2 (A)	1103	0.2408%
1110	C3	1574	0.3436%
1111	A1	878	0.1917%
1112	B5	1178	0.2572%
1113	B3 (A)	1209	0.2639%
1201	B2 (A)	1103	0.2408%
1202	C1	1326	0.2895%
1203	B3 (B)	1209	0.2639%
1204	C2 (B)	1389	0.3032%
1205	C2	1397	0.3050%
1206	B3	1209	0.2639%
1207	A3	732	0.1598%
1208	C1	1326	0.2895%
1209	B2 (A)	1103	0.2408%

1210	C3	1574	0.3436%
1211	A1	878	0.1917%
1212	B5	1178	0.2572%
1213	B3 (A)	1209	0.2639%
1301	B4	1160	0.2532%
1302	C1 (A)	1326	0.2895%
1303	B2 (B)	1103	0.2408%
1304	A2 (B)	851	0.1858%
1305	B5 (A)	1178	0.2572%
1306	B5	1178	0.2572%
1307	A2 (A)	851	0.1858%
1308	A2	790	0.1725%
1309	B2	1103	0.2408%
1310	C1	1326	0.2895%
1311	A2	790	0.1725%
1312	A2 (A)	851	0.1858%
1313	C2	1397	0.3050%
1314	B1	1159	0.2530%
1401	B2 (A)	1103	0.2408%
1402	C1	1326	0.2895%
1403	B3 (B)	1209	0.2639%
1404	C2 (B)	1389	0.3032%
1405	C2	1397	0.3050%
1406	B3 (A)	1209	0.2639%
1407	C1 (C)	1326	0.2895%
1408	B2 (A)	1103	0.2408%
1409	C3	1574	0.3436%
1410	A1	878	0.1917%
1411	B5	1178	0.2572%
1412	B3 (A)	1209	0.2639%
1501	B3 (B)	1209	0.2639%
1502	C1	1326	0.2895%
1503	B2 (A)	1103	0.2408%
1504	B3 (A)	1209	0.2639%
1505	B5	1178	0.2572%
1506	A1	878	0.1917%
1507	C3	1574	0.3436%
1508	B2 (A)	1103	0.2408%
1509	C1	1326	0.2895%
1510	A3	732	0.1598%
1511	B3	1209	0.2639%
1512	C2	1397	0.3050%
1513	C2 (B)	1389	0.3032%
1601	B4	1160	0.2532%
1602	C1 (A)	1326	0.2895%
1603	B2	1103	0.2408%
1604	A2	790	0.1725%
1605	A2 (A)	851	0.1858%
1606	B5	1178	0.2572%
1607	B5	1178	0.2572%
1608	A2 (A)	851	0.1858%
1609	A2	790	0.1725%

1610	B2	1103	0.2408%
1611	C1 (B)	1326	0.2895%
1612	A2 (B)	851	0.1858%
1613	C2 (A)	1397	0.3050%
1614	B1	1159	0.2530%
1701	B2 (B)	1103	0.2408%
1702	C1 (A)	1326	0.2895%
1703	B4	1160	0.2532%
1704	B1	1159	0.2530%
1705	C2	1397	0.3050%
1706	A2 (A)	851	0.1858%
1707	A2	790	0.1725%
1708	C1	1326	0.2895%
1709	B2	1103	0.2408%
1710	A2	790	0.1725%
1711	A2 (A)	851	0.1858%
1712	B5	1178	0.2572%
1713	B5 (A)	1178	0.2572%
1714	A2 (B)	851	0.1858%
1801	B4	1160	0.2532%
1802	C1 (A)	1326	0.2895%
1803	B2	1103	0.2408%
1804	A2	790	0.1725%
1805	A2 (A)	851	0.1858%
1806	B5	1178	0.2572%
1807	B5	1178	0.2572%
1808	A2 (A)	851	0.1858%
1809	A2	790	0.1725%
1810	B2	1103	0.2408%
1811	C1 (B)	1326	0.2895%
1812	A2 (B)	851	0.1858%
1813	C2 (A)	1397	0.3050%
1814	B1	1159	0.2530%
1901	A2	790	0.1725%
1902	B2	1103	0.2408%
1903	C1 (A)	1326	0.2895%
1904	B4	1160	0.2532%
1905	B1	1159	0.2530%
1906	C2 (A)	1397	0.3050%
1907	A2 (B)	851	0.1858%
1908	C1 (B)	1326	0.2895%
1909	B2	1103	0.2408%
1910	A2	790	0.1725%
1911	A2 (A)	851	0.1858%
1912	B5	1178	0.2572%
1913	B5	1178	0.2572%
1914	A2 (A)	851	0.1858%
2001	B2 (A)	1103	0.2408%
2002	C1	1326	0.2895%
2003	B3 (B)	1209	0.2639%
2004	C2 (B)	1389	0.3032%
2005	C2	1397	0.3050%

2006	B3	1209	0.2639%
2007	A3	732	0.1598%
2008	C1	1326	0.2895%
2009	B2 (A)	1103	0.2408%
2010	C3	1574	0.3436%
2011	A1	878	0.1917%
2012	B5	1178	0.2572%
2013	B3 (A)	1209	0.2639%
2101	B4	1160	0.2532%
2102	C1 (A)	1326	0.2895%
2103	B2	1103	0.2408%
2104	A2	790	0.1725%
2105	A2 (A)	851	0.1858%
2106	B5	1178	0.2572%
2107	B5	1178	0.2572%
2108	A2 (A)	851	0.1858%
2109	A2	790	0.1725%
2110	B2	1103	0.2408%
2111	C1 (B)	1326	0.2895%
2112	A2 (B)	851	0.1858%
2113	C2 (A)	1397	0.3050%
2114	B1	1159	0.2530%
2201	B4	1160	0.2532%
2202	C1 (A)	1326	0.2895%
2203	B2 (B)	1103	0.2408%
2204	A2 (B)	851	0.1858%
2205	B5 (A)	1178	0.2572%
2206	B5	1178	0.2572%
2207	A2 (A)	851	0.1858%
2208	A2	790	0.1725%
2209	B2	1103	0.2408%
2210	C1	1326	0.2895%
2211	A2	790	0.1725%
2212	A2 (A)	851	0.1858%
2213	C2	1397	0.3050%
2214	B1	1159	0.2530%
2301	B4	1160	0.2532%
2302	C1 (A)	1326	0.2895%
2303	B2	1103	0.2408%
2304	A2	790	0.1725%
2305	A2 (A)	851	0.1858%
2306	B5	1178	0.2572%
2307	B5	1178	0.2572%
2308	A2 (A)	851	0.1858%
2309	A2	790	0.1725%
2310	B2	1103	0.2408%
2311	C1 (B)	1326	0.2895%
2312	A2 (B)	851	0.1858%
2313	C2 (A)	1397	0.3050%
2314	B1	1159	0.2530%
2401	B4	1160	0.2532%
2402	C1 (A)	1326	0.2895%

2403	B2	1103	0.2408%
2404	A2	790	0.1725%
2405	A2 (A)	851	0.1858%
2406	B5	1178	0.2572%
2407	B5	1178	0.2572%
2408	A2 (A)	851	0.1858%
2409	A2	790	0.1725%
2410	B2	1103	0.2408%
2411	C1 (B)	1326	0.2895%
2412	A2 (B)	851	0.1858%
2413	C2 (A)	1397	0.3050%
2414	B1	1159	0.2530%
2501	B2 (A)	1103	0.2408%
2502	C1	1326	0.2895%
2503	B3 (B)	1209	0.2639%
2504	C2 (B)	1389	0.3032%
2505	C2	1397	0.3050%
2506	B3	1209	0.2639%
2507	A3	732	0.1598%
2508	C1	1326	0.2895%
2509	B2 (A)	1103	0.2408%
2510	C3	1574	0.3436%
2511	A1	878	0.1917%
2512	B5	1178	0.2572%
2513	B3 (A)	1209	0.2639%
2601	A2	790	0.1725%
2602	B2	1103	0.2408%
2603	C1 (A)	1326	0.2895%
2604	B4	1160	0.2532%
2605	B1	1159	0.2530%
2606	C2 (A)	1397	0.3050%
2607	A2 (B)	851	0.1858%
2608	C1 (B)	1326	0.2895%
2609	B2	1103	0.2408%
2610	A2	790	0.1725%
2611	A2 (A)	851	0.1858%
2612	B5	1178	0.2572%
2613	B5	1178	0.2572%
2614	A2 (A)	851	0.1858%
2701	A2	790	0.1725%
2702	B2	1103	0.2408%
2703	C1 (A)	1326	0.2895%
2704	B4	1160	0.2532%
2705	B1	1159	0.2530%
2706	C2 (A)	1397	0.3050%
2707	A2 (B)	851	0.1858%
2708	C1 (B)	1326	0.2895%
2709	B2	1103	0.2408%
2710	A2	790	0.1725%
2711	A2 (A)	851	0.1858%
2712	B5	1178	0.2572%
2713	B5	1178	0.2572%

2714	A2 (A)	851	0.1858%
2801	B2 (A)	1103	0.2408%
2802	C1	1326	0.2895%
2803	B3 (B)	1209	0.2639%
2804	C2 (B)	1389	0.3032%
2805	C2	1397	0.3050%
2806	B3 (A)	1209	0.2639%
2807	C1 (C)	1326	0.2895%
2808	B2 (A)	1103	0.2408%
2809	C3	1574	0.3436%
2810	A1	878	0.1917%
2811	B5	1178	0.2572%
2812	B3 (A)	1209	0.2639%
2901	B3 (B)	1209	0.2639%
2902	C1	1326	0.2895%
2903	B2 (A)	1103	0.2408%
2904	B3 (A)	1209	0.2639%
2905	B5	1178	0.2572%
2906	A1	878	0.1917%
2907	C3	1574	0.3436%
2908	B2 (A)	1103	0.2408%
2909	C1	1326	0.2895%
2910	A3	732	0.1598%
2911	B3	1209	0.2639%
2912	C2	1397	0.3050%
2913	C2 (B)	1389	0.3032%
3001	B2 (B)	1103	0.2408%
3002	C1 (A)	1326	0.2895%
3003	B4	1160	0.2532%
3004	B1	1159	0.2530%
3005	C2	1397	0.3050%
3006	A2 (A)	851	0.1858%
3007	A2	790	0.1725%
3008	C1	1326	0.2895%
3009	B2	1103	0.2408%
3010	A2	790	0.1725%
3011	A2 (A)	851	0.1858%
3012	B5	1178	0.2572%
3013	B5 (A)	1178	0.2572%
3014	A2 (B)	851	0.1858%